

A **HAVELLS** Brand

LLOYD

User's Manual

FRONT LOAD WASHING MACHINE

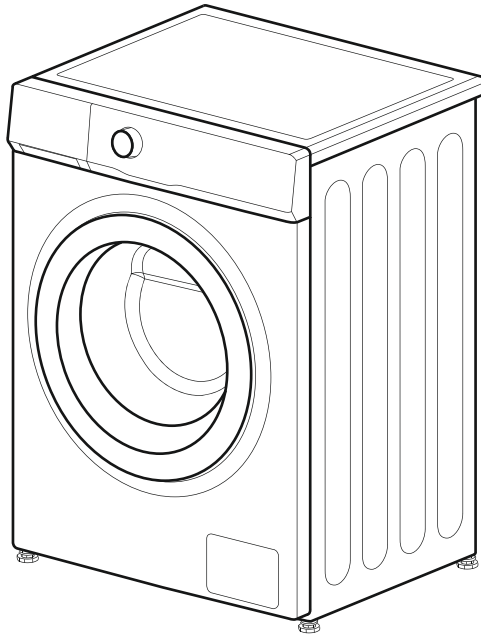

GLWF804TSGGB

Please read this manual carefully before operating the machine

Dear Customer,

Congratulations on being the proud owner of Lloyd Washing Machine. Your Washing Machine comes with the Lloyd Guarantee of Quality.

Lloyd takes great pride in providing its customers with perfect products that adhere to international quality standards.

Lloyd is committed to provide the ultimate customer satisfaction and the Company takes great pride in having satisfied customers.

At Lloyd, feedback and suggestions based on your product usage are greatly appreciated.

Please feel free to contact us at:
customercare@havells.com

TEAM LLOYD

CONTENT PAGE

SAFETY INSTRUCTIONS	1
SPECIFICATIONS	7
ENERGY SAVING GUIDE	8
INSTALLATION	9
OPERATION	13
MAINTENANCE	26
WARRANTY	31
WARRANTY REGISTRATION CARD	33
E-WASTE DISPOSAL	35



Read all instructions and explanations before use. Follow the instructions carefully. Keep the operation instructions handy for later use. If the appliance is sold or passed on then ensure that the new owner always receives these operation instructions.

NOTE: This revised user manual is effective from August, 2024

SAFETY INSTRUCTIONS

■ Safety Instructions

Please read the following safety information thoroughly and follow it strictly to minimize the risk of fire or explosion, electric shock and to prevent property damage, personal injury or loss of life. Failing to follow these instructions shall void any warranty.

Warning!

This combination of symbol and signal word indicates a potentially dangerous situation which may result in death or serious injuries unless it's avoided.

Caution!

This combination of symbol and signal word indicates a potentially dangerous situation which may result in slight or minor injuries or damage to property and the environment.

Note!

This combination of symbol and signal word indicates a potentially dangerous situation which may result in slight or minor injuries.

Warning!

ELECTRIC SHOCK HAZARD

- If the supply cord is damaged, it must be replaced by the manufacturer, its service agent or similarly qualified persons in order to avoid a hazard.
 - If the machine is damaged, it must not be operated unless repaired by the manufacturer, its service agent or similarly qualified persons.
- Risk of electric shock!

SAFETY INSTRUCTIONS

The appliance can be used by children aged from 8 years and above and persons with reduced physical, sensory or mental capabilities or lack of experience and knowledge if they have been given supervision or instruction concerning use of the appliance in a safe way and understand the hazards involved. Children shall not play with the appliance. Cleaning and user maintenance shall not be made by children without supervision.

Children should be supervised that they do not play with the appliance.

Children 3 years and under shall be kept away from the appliance or continuously supervised.

Animals and children may climb into the machine. Check the machine before every operation.

Do not climb or sit on the appliance.

INSTALLATION LOCATION AND SURROUNDING

All washing and additional substances are to be kept in a safe place out of the reach of children.

Do not install the machine on a carpet floor. The obstruction of the openings by a carpet can damage the machine.

Keep the appliance clear from heating sources and direct sunlight to avoid plastic and rubber parts to corrode.

Do not use the appliance in humid environments or rooms containing explosive or caustic gas. In case of water leakage or water splashes let the appliance dry in the open air.

The appliance must not be installed behind a lockable door, a sliding door or a door with a hinge on the opposite side to that of the washing machine.

SAFETY INSTRUCTIONS

Do not operate the machine in rooms with a temperature of below 5°C. This can cause damages to parts of it. If it is unavoidable, make sure to drain the water completely from the appliance after every use (see Maintenance - Cleaning of drain pump filter) to avoid damages caused by frost.

Never use flammable sprays or substances in the immediate proximity of the appliance.

INSTALLATION

Remove all packaging material and transport bolts before using the appliance. Otherwise, serious damage may result.

This appliance is equipped with a single inlet valve and can be connected to the cold water supply only.

Mains plug must be accessible after installation.

Before washing clothes for the first time, the product shall be operated once throughout all the procedures without any clothes inside.

Before using the washing machine, the product shall be calibrated.

Do not put any excessively heavy objects on the appliance, like water containers or heating devices.

The new hose-sets supplied with the appliance are to be used and that old hose-sets should not be reused.

Max. Inlet water pressure 1 MPa. Min. inlet water pressure 0.05 MPa.

ELECTRICAL CONNECTION

Make sure the supply cable is not trapped by the machine, it can get damaged.

Connect the product to a grounded outlet protected by a fuse complying with the values in the Technical specifications table. The grounding installation has to be made by a qualified electrician. Ensure that the machine is installed in accordance with the local regulations.

SAFETY INSTRUCTIONS

Water and electrical connections must be carried out by a qualified technician in accordance with the manufacturer's instructions and local safety regulations.

Warning!

Don't use multiple plugs or extension cords.

The appliance must not have an external switching device such as a timer or connected to a circuit that is regularly switched on and off.

Do not pull the plug out of the mains outlet if there is flammable gas around.

Never pull out power plug with wet hands.

Always pull at the plug, not at the cable.

Always unplug the appliance if it is not being used.

WATER CONNECTIONS

Check the connections of the water inlet tubes, the water tap and the outlet hose for possible problems due to changes of water pressure. If the connections loosen or leak close the water tap and get it repaired. Do not use the appliance before the pipes and hoses are installed properly by qualified persons.

Glass door may become very hot during the operation. Keep children and pets far away from the machine while it is operating.

The water inlet and outlet hoses have to be safely installed and remain undamaged. Otherwise, water leakage can occur.

Do not remove the drain pump filter while there is still water in the appliance. Big quantities of water can leak out, and there is a risk of scalding due to hot water.

SAFETY INSTRUCTIONS

OPERATION AND MAINTENANCE

Never use any flammable, explosive or toxic solvents. Do not use gasoline and alcohol etc. as detergents. Only select detergents that are suitable for machine washing.

Make sure that all pockets are emptied. Sharp and rigid items such as coins, brooches, nails, screws, stones etc. may cause serious damages to this machine.

Remove all objects from pockets such as lighters and matches before use the appliance.

Thoroughly rinse items that have been washed by hand.

Items that have been soiled with substances such as cooking oil, acetone, alcohol, petrol, kerosene, spot removers, turpentine, wax and wax removers should be washed in hot with an extra amount of detergent before being dried in the appliance.

Items containing foam rubber (latex foam), shower caps, water proof textiles, rubber backed articles and clothes or pillows fitted with foam rubber pads should not be dried in the machine

Fabric softeners or similar products should be used as recommended in their instructions.

Never try to open the door forcefully. The door will unlock shortly after the end of a cycle.

Please do not close the door with excessive force. If it is found difficult to close the door, please check if the clothes are properly inserted and distributed.

SAFETY INSTRUCTIONS

Always unplug the appliance and close the water tap before cleaning and maintenance and after each use.

Never pour water over the appliance for cleaning purpose. Risk of electric shock!

Repairs shall only be carried out by the manufacturer, its service agent or similarly qualified persons in order to avoid a hazard. The producer will not be responsible for damages caused by the intervention of not authorized persons.

TRANSPORT

Before Transport:

- Bolts shall be reinstalled to the machine by a specialized person
- Accumulated water shall be drained out of the machine

This appliance is heavy. Transport with care. Never hold any protruding part of the machine when lifting. The machine door cannot be used as a handle.

INTENDED USE

The product is intended only for home use and for textiles in household amounts suitable for machine washing and drying. This appliance is for indoor use only and not intended for built in use. Only use according to these instructions. The appliance is not intended for commercial use.

Any other use is considered as improper use. The producer is not responsible for any damage or injuries that may result of it.

This appliance is intended to be used in household and similar applications such as:

- Staff kitchen areas in shops, offices and other working environments;
- Farm houses;
- By clients in hotels, motels and other residential type environments;
- Bed and breakfast type environments;
- Areas for communal use in blocks of flats or in launderettes.

TECHNICAL SPECIFICATIONS

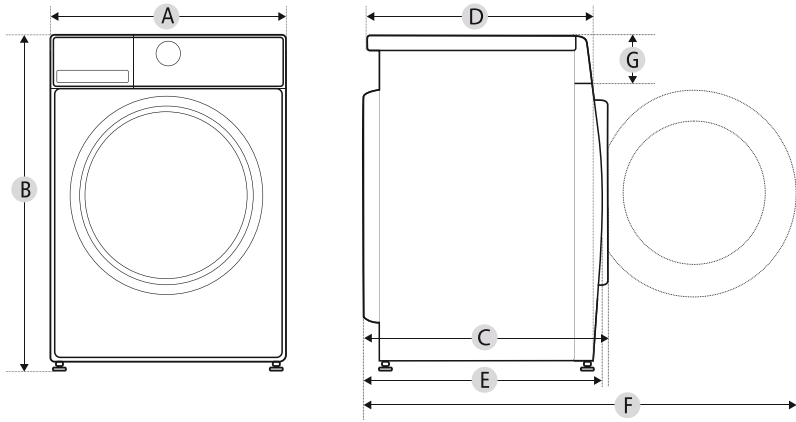

Model	GLWF804TSGGB
Power Supply	220 V-240 V~50Hz
MAX.Current	10A
Standard Water Pressure	0.05 MPa ~ 1 MPa
Washing Capacity	8.0 kg
Dimension	
A	595 mm
B	850 mm
C	540 mm
Weight	63 kg
Rated Power	1950 W
Reference Dimension	
D	475 mm
E	521 mm
F	985 mm
G	135 mm

ENERGY SAVING GUIDE

To enter into the energy Saving mode follow below guide:

1 Press the **POWER** button to turn power on.  Power

2 Press the **PROGRAM** button to select the **ECO 40-60** program.

3 Close the lid & press the **START/PAUSE** button.  Start
Pause

NOTE :

Under test conditions, When tested in accordance with standard IEC 60456 : 2010 Actual performance of machine will depend on how the appliance is being used.

INSTALLATION

■ Product Description

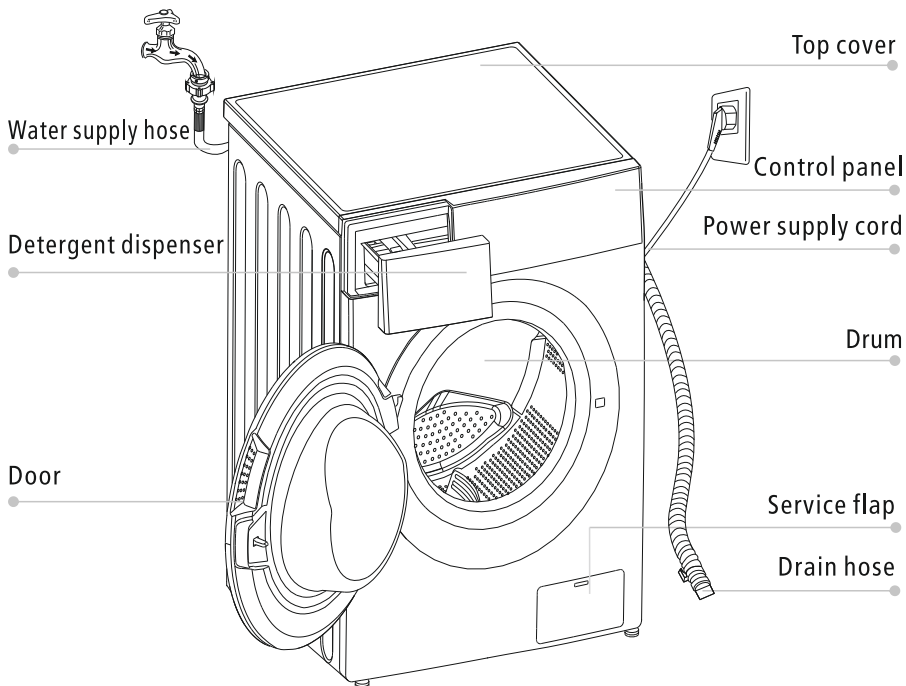

Note!

" The product picture is for illustration only, please refer to real product as reference.

Accessories

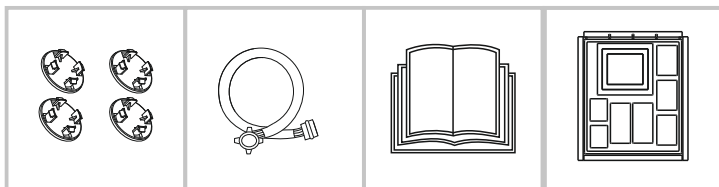

4 x Cover caps

1 x Supply hose
cold water

1 x User Manual

Rat mesh

INSTALLATION

■ Installation

Installation area

△ Warning!

Stability is important to prevent the product from wandering! Make sure the machine is standing leveled and stable.

" Make sure that the product does not stand onto the power cord.

" Make sure to maintain the minimum distances from the walls as shown in the picture

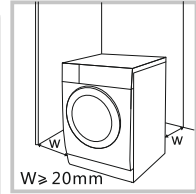

Before installing the machine, the location characterized as follows shall be selected:

1. Rigid, dry, and level surface
2. Avoid direct sunlight
3. Sufficient ventilation
4. Room temperature is above 0°C
5. Keep far away from the heat sources such as coal or gas burning appliances.

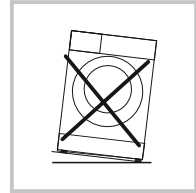

Unpacking the washing machine

△ Warning!

" Packaging material (e.g. Films, Styrofoam) can be dangerous for children.

" There is a risk of suffocation ! Keep all packaging well away from children.

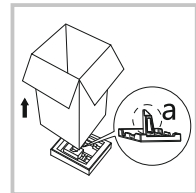

1. Remove the cardboard box and styrofoam packing.
2. Lift the washing machine and remove the base packaging. Make sure the small triangle foam (a) is removed with the bottom packaging together. If not, lay the unit down on the side surface and remove it manually.
3. Remove the tape securing the power supply cord and drain hose.
4. Remove the inlet hose from the drum.

INSTALLATION

Remove transport bolts

⚠ Warning!

" You must remove the transport bolts from the backside before using the product.



Loosen the 4 transport bolts with a spanner.



Remove the bolts including the rubber parts and keep them for future use.

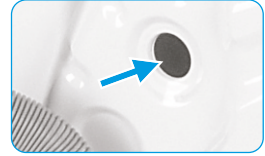

Close the holes using the cover caps.

Levelling the washing machine

⚠ Warning!

" The lock nuts on all four feet must be screwed tightly against the housing.

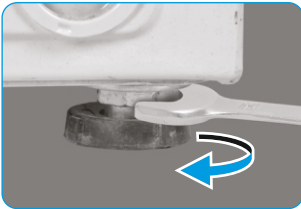

1. Loosen the lock nut.
2. Turn the foot until it reaches the floor.
3. Adjust the legs and lock the nuts with a spanner. Make sure the machine is level and steady.

Connect the water supply hose

⚠ Warning!

To prevent leakage or water damage, follow the instructions in this chapter
" Do not kink, crush or modify water inlet hose.



Connect the water supply hose to the water inlet valve and a water tap with cold water as indicated.



🔧 Note!

" Connect manually, do not use tools. Check if the connections are tight.

INSTALLATION

Drain Hose

Warning!

- " Do not kink or protract the drain hose.
- " Position drain hose properly ,otherwise damage might result of water leakage.

There are two ways to place the end of drain hose:

1.Put it into the water trough.

2.Connect it to the branch drain pipe of the trough.

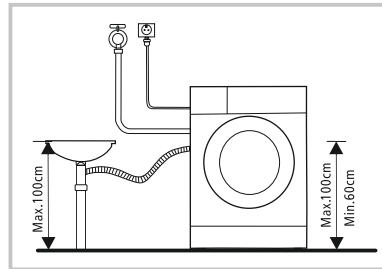
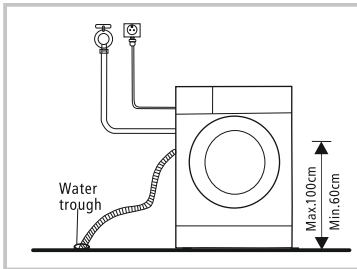

OPERATION

■ Quick Start

⚠ Caution!

- " Before washing, please make sure the washing machine is installed properly.
- " Your appliance was thoroughly checked before it left the factory. To remove any residual water and to neutralize potential odors, it's recommended to clean your appliance before first use. For this reason, start the Cotton program at 90°C without laundry and detergent.

📌 Calibration

It's recommended to calibrate the washing machine, so that provide the best performance.

The appliance is able to detect the amount of laundry loaded. This function is optimizing the product performance by minimizing energy and water consumption, saving you money and time. For this reason its recommended to calibrate the appliance for best use.

- 1- Remove all accessories from the drum and close the door;
- 2- Insert the mains plug to the socket;
- 3- Switch on the washing machine and press "Boost" and "Temp." simultaneously for 10 seconds until "t19" is displayed;
- 4- Press [▷||] to start the appliance and wait till "*****" is displayed.

OPERATION

1. Before Washing

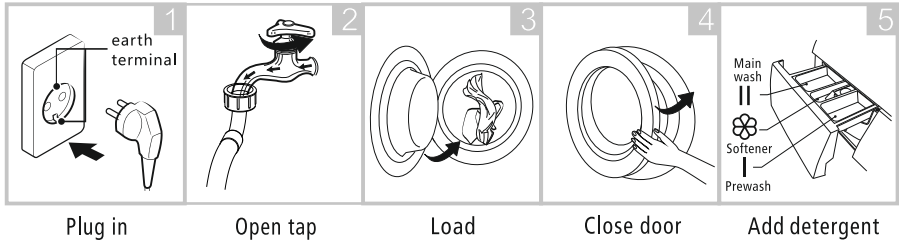

Note!

- " Detergent need to be added in compartment I if the pre-wash function is selected.
- " Do not put laundry beads into the detergent dispenser.

2. Washing

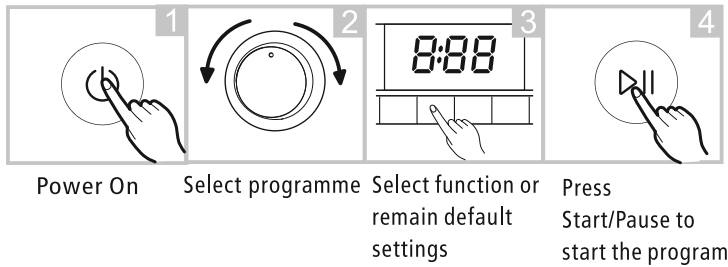

3. After Washing

Buzzer beep and "End" on display.

OPERATION

■ Before Each Washing

- " The ambient temperature of the washing machine should be 5-40°C. If used under 0°C, the inlet valve and draining system may be damaged. If the machine is installed under freezing conditions, it should be transferred to normal ambient temperature to ensure the water supply hose and drain hose can unfreeze before use.
- " Please check your laundry care labels and the detergent use instructions before wash. Use non-foaming or less-foaming detergent suitable for machine washing properly.

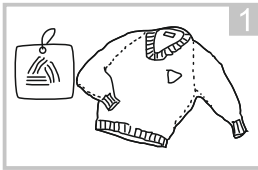

Check the care label

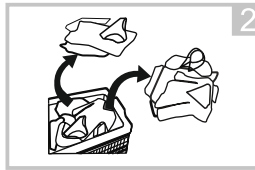

Sort laundry according to color and textile type

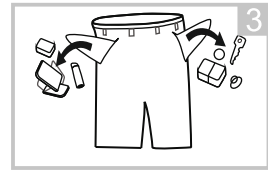

Take all items out of the pockets

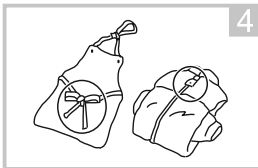

Tie together long textile strips and belts, close zips and button

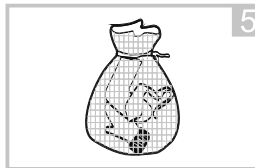

Put small items into a laundry bag

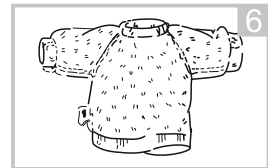

Turn easy-pilling and long-pile fabric inside out

⚠ Warning!

- When washing a single cloth, it may easily cause great eccentricity and give alarm due to great unbalance. Therefore it is suggested to add one or two more clothes to be washed together so that draining can be done smoothly.
- Don't wash the clothes touching with kerosene, gasoline, alcohol and other flammable materials.
- Do not wash, spin, or dry water-proof seats, mats, or clothing.

OPERATION

■ Detergent Dispenser

- I Pre wash
- II Main wash
- ☼ Softener
- ⊖ Release button to pull out the dispenser

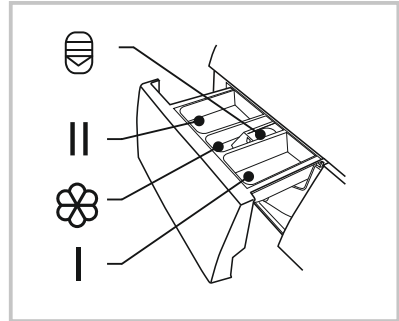

⚠ Caution!

- Detergent only need to be added in "compartment I "after selecting pre-wash function.
- Do not put laundry beads into the detergent dispenser.

Programme	I	II / △	☼	Programme	I	II / △	☼
Cotton	○	●	○	Quick 45'/15'		●	○
Synthetic	○	●	○	Steam Treat	○	●	○
Mix	○	●	○	ECO 40-60		●	○
Baby Care	○	●	○	20°C		●	○
Sports	○	●	○	Wool		●	○
Jeans	○	●	○	Spin Only			
				Drum Clean			

● Means must ○ Means optional

OPERATION

Detergent Recommendation

Recommended washing detergent	Wash cycles	Washing temp.	Type of laundry and textile
Heavy-duty detergent with bleaching agents and optical brighteners	Cotton, ECO 40-60, Mix	40/60/90	White laundry made from boil-proof cotton or linen
Colour detergent without bleaching agent and optical brighteners	Cotton, ECO 40-60, Mix, Sports	20/30/40	Coloured laundry made from cotton or linen
Color or mild detergent without optical brighteners	20°C	20	Coloured laundry made from easy care fibres or synthetic materials
Mild washing detergent	Delicate	20 /30	Delicate textiles, silk, viscose

Note!

- Agglomerating or ropy detergent or additive can be diluted in some water before pouring it into the detergent dispenser, to avoid its inlet to get blocked and thus cause a water overflow.
- Please choose the suitable type of detergent to get a maximum of washing performance and a minimum of water and energy consumption
- To achieve the best cleaning result a proper detergent dosing is important.
- Use a reduced detergent amount if the drum is not filled completely.
- Always adjust the amount of detergent to the water hardness, if your tap water is soft, use less detergent.
- Dose according to how dirty your laundry is, less dirty clothes require less detergent.
- Highly concentrated (compact detergent) requires particularly accurate dosing.

Following symptoms are a sign of detergent overdosing:

- heavy foam formation
- poor washing and rinsing result

Following symptoms are a sign of detergent underdosing:

- laundry turns grey
- built-up of limescale deposits on the drum, the heating element and/or the laundry

OPERATION

■ Control Panel

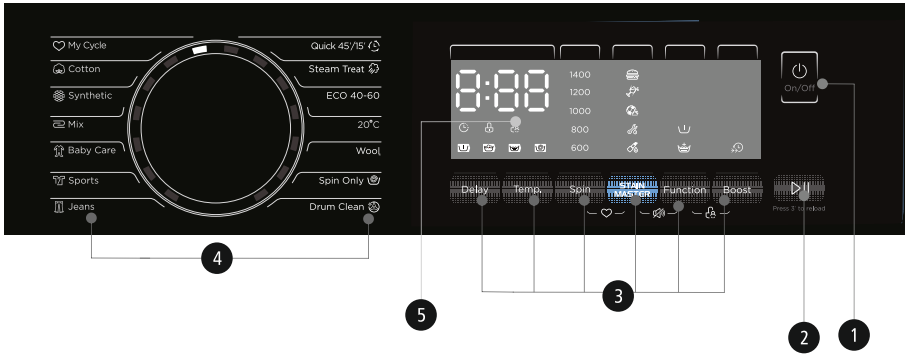

1 Power

Product is on/off.

2 Start/Pause

Press the button to start or pause the washing cycle.

3 Option

This allows you to select an additional function and will light when selected.

4 Programmes

Available according to the laundry type.

5 Display

The display shows the settings, estimated time remaining, options, and status messages for your washer. The display will remain on through the cycle.

A Display	
Wash Time	Delay Time
125	2H
Speed	Error
400	E30
End	Temp.
End	30

B Pre Wash	C Door Lock
D Child Lock	E Delay
F Boost	G Stain Master
H Extra Rinse	
I Pre Wash-Wash-Rinse-Spin	

OPERATION

■ Programmes

Programme	Load(kg)	Default Time
	8.0	8.0
Quick 45'/15'	2.0	0:45
Steam Treat	3.5	2:28
ECO 40-60	8.0	3:28
20°C	3.5	1:01
Wool	2.0	1:07
Spin Only	8.0	0:12
Drum Clean	–	1:18
Jeans	8.0	1:35
Sports	3.5	0:47
Baby Care	8.0	2:01
Mix	8.0	1:20
Synthetic	3.5	3:18
Cotton	8.0	3:39

- Cotton, Mix, Synthetic are auto Weighting programs. When these 3 programs are selected, the washing machine will automatically adjust the appropriate water level and wash time according to the weight of the laundry during the washing process.

OPERATION

■ Programmes

Programmes are available according to the laundry type.

Programmes	
Cotton	Hard-wearing textiles, heat-resistant textiles made of cotton or linen.
Synthetic	Wash synthetic articles, for example: shirts, coats, blending. While washing the knitting textiles, detergent quantity shall be reduced due to its loose string construction and easily forming bubbles.
Mix	Mixed load consisting of textiles made of cotton and synthetics.
Baby Care	Washing the baby's clothes, it can make the baby's wear cleaner and make the rinse performance better to protect the baby skin.
Sports	Washing the activewear.
Jeans	Specially for jeans.
Drum Clean	Specially set in this machine to clean the drum and tube. It applies 90 °C high temperature sterilization to make the clothes washing more green. When this programme is performed, the clothes or other washing cannot be added. When proper amount of chlorine bleaching agent is put in, the barrel cleaning effect will be better. The customer can use this programme regularly according to the need.
Spin Only	Spins and drains the water.
Wool	Hand or machine-washable wool or richwool textiles. Especially gentle wash programme to prevent shrinkage, longer programme pauses (textiles rest in wash liquor).
20 °C	Able to clean lightly soiled cotton laundry, at a nominal temperature of 20 °C.
ECO 40-60	Able to clean normally soiled cotton laundry declared to be washable at 40 °C or 60 °C, together in the same cycle.
Steam Treat	Steam is applicable for daily laundries. The steam can deeply penetrate the fiber, which effectively eliminate bacterias and germs, preventing odors and protecting your health.
Quick 45'/15'	This procedure defaults to 45', press the "Boost" to switch to 15', which is suitable for washing few and not very dirty clothes quickly. Sometimes, after the quick 15' procedure is completed, the moisture content of clothes is high.































OPERATION

⚠ Caution!

- If there is any break in the power supply while the machine is operating, a special memory stores the selected programme. The machine will continue the programme when the power supply is re-established.

OPERATION

■ Option

Cycle	Default Temp.(°C)	Default spin speed in rpm	Additional functions
Wash cycles		1400	
Quick 45'/15'	20	800	  
Steam Treat	60	1000	  
ECO 40-60	–	1400	
20°C	20	1000	  
Wool	40	600	 
Spin Only	–	1000	
Drum Clean	90	–	
Jeans	30	800	  
Sports	20	800	 
Baby Care	60	1000	  
Mix	40	1000	  
Synthetic	40	1200	  
Cotton	40	1400	  

Note!

- For the maximum spin speed, program time, and other details of the ECO 40-60 program, please refer to the content on the Product Fiche page.
- The table shows which cycle offers which options for adjustment. If an adjustment is not possible for a cycle.

OPERATION

Temp.

Temp.

When needed, the washing temperature can be adjusted by pressing the temperature button in the following steps: Cold - 20°C - 30°C - 40°C - 60°C - 90°C.

Spin

Spin

When needed, the spinning speed can be adjusted pressing the Speed button in the following steps:

1400: 0-600-800-1000-1200-1400

Delay

Delay

1. Select a programme
2. Press the Delay button to choose the delaying time 0-24h
3. Press [Start/Pause] to start the delay operation



Choose programme

Setting time

Start

To cancel the Delay function, press the "Delay" button before starting the program until the display shows 0 h. If the program has already started, switch the appliance off and afterwards on and select a new programme.



Pre Wash

Extra washing function before the main washing cycle starts to increase the washing performance.

Note: Detergent needs to be added to the compartment I.



Extra Rinse

The laundry will undergo an extra rinse after selecting this function.



Boost

The function can decrease the washing time.



Stain Master

Stain Master offers specific treatments for five scenarios (Food, Drinks, Sports & Fitness, Outdoor & Workers, Health & Beauty) to professionally solve according laundry problems

STAIN MASTER	scenarios	Wash Cycles	Typical stain
	Food	Cotton, Synthetics, Mix, Baby Care, Jeans	Fresh Vegetables, Fresh Juice, Food Sauce
	Drinks	Cotton, Synthetics, Mix, Baby Care	Red wine, hot drink, soft drink
	Sports & Fitness	Cotton, Synthetics, Mix, Sports	Grass Stains, Dust, Sweat Stains
	Outdoor & Workers	Cotton, Synthetics, Mix, Sports, Jeans	Grease, Mud Stain, Carbon Pigment
	Health & Beauty	Cotton, Synthetics, Mix	Cosmetics, Blood, Drugs

OPERATION



My Cycle

To memory the frequently used programme.

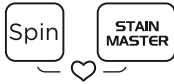

After choosing the programme and setting the options, press [Spin] and [Stain Master] button 3 sec. before start to wash. The default setting course is Cotton.



Child Lock

This function is meant to keep children from misusing the controls.

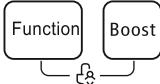

Press [Function] and [Boost] simultaneously for 3 sec until the buzzer beep. The child lock indicator switches on.

⚠ Caution!

When the Child Lock is activated, the display will alternately show "CL" and the remaining time.

Pressing any other button will cause the Child Lock indicator to flash.

When the program ends, "Cl" and "END" will alternate on the display.

The Child Lock deactivates the function of all buttons except the On/Off button and the Child lock button!

Only the simultaneous pressing of the two buttons [Function] and [Boost] can deactivate the Child Lock!

Please deactivate the Child Lock before selecting a new program!



Mute the buzzer



Choose the Programme



Press the [Stain Master] and [Function] button for 3sec., the buzzer is mute.

To act the buzzer function, press the button again for 3 seconds. The setting will be kept until the next reset.

⚠ Caution!

- After Muting the buzzer function, the sounds will not be activated any more.

OPERATION



Reload

This operation can be executed during the washing progress. When the drum is still rolling and there is large amount of water with high temperature in the drum. The state is unsafe and the door cannot be opened forcefully. To press [Start/Pause] for 3 sec. to reload, and start the clothes adding in the midway function. Please follow the steps as bellow:

- 1.Wait until the drum stops rotation.
- 2.The door lock is unlocked.
- 3.Close the door when the clothes are reloaded and press the [▷||] button.

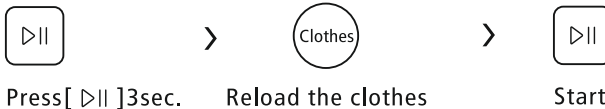

⚠ Caution!

" Don't use the Reload function when the water level over the edge of the inner tub or the temperature is higher.

📌 Note!

Usage counter

1. Unplug the equipment for 10s and reconnect again.
- 2.Power on and within 10s, please press " Delay" and "Boost" on control panel simultaneously and continuously for around 5s until the device display shows digits--the value can indicate the times of equipment usage.
- 3.Repeat step 1 again and customer can resume to normal operation.

MAINTENANCE

■ Cleaning and Care

⚠ Warning!

Always unplug the appliance and close the water tap before cleaning and maintenance.

Cleaning the Cabinet

Proper maintenance on the washing machine can extend its working life. The surface can be cleaned with diluted non-abrasive neutral detergents when necessary. If there is any water overflow, use a cloth to wipe it off immediately. Never use sharp items to clean the appliance.

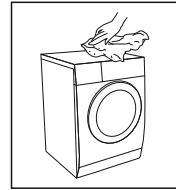

⚠ Caution!

" Never use abrasive or caustic agents, formic acids or its diluted solvents or similar substances, like alcohol or chemical products.

Cleaning the Drum

Any rust stains left inside the drum by metal articles must be removed immediately using chlorine-free detergents. Never use steel wool for cleaning the drum!

📌 Note!

" Keep any laundry away from the machine while cleaning the drum.

Cleaning the Door Seal and Glass

Wipe the glass and seal after each wash to remove lint and stains. If lint builds up it can cause leakages. Remove any coins, buttons and other objects from the seal after each wash. Clean the Door Seal and Glass every month to ensure the normal operation of the appliance.

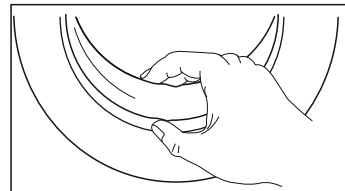

MAINTENANCE

Cleaning the Inlet Filter

Note!

1. Close the tap and remove the water supply hose from it.
2. Clean the filter with a brush.
3. Unscrew the water supply hose from the backside of the machine. Pull out the filter with long nose pliers.
4. Use a brush to clean the filter.
5. Reinstall the filter to the water inlet and reconnect the water supply hose.
6. Clean the Inlet filter every 3 months to ensure the normal operation of the appliance.

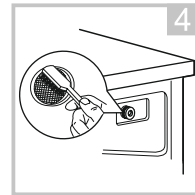
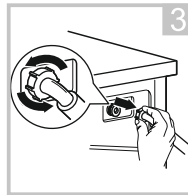
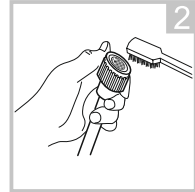
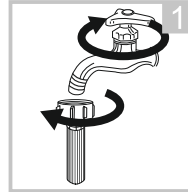

Clean The Detergent Dispenser

1. Press down the release [] on the softener cover and pull the dispenser drawer out of the recess. Clean the inside of the recess with a brush.
2. Lift the softener cover off the dispenser drawer and wash both items with water.
3. Restore the softener cover and push the drawer back into the recess.

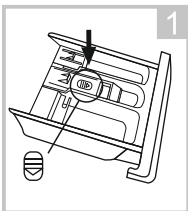

Press the release and remove the dispenser drawer

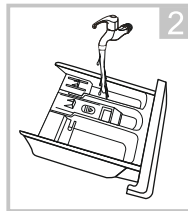

Clean the dispenser drawer and the softener cover under water

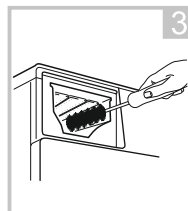

Clean the recess with an soft brush

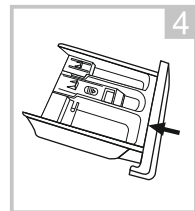

Insert the dispenser drawer

Note!

- Do not use abrasive or caustic agents to clean plastic parts.
- Clean the detergent dispenser every 3 months to ensure the normal operation of the appliance.

MAINTENANCE

Cleaning the Drain Pump Filter

⚠ Warning!

- Make sure that the machine has finished the washing cycle and is empty. Switch it off and unplug it before cleaning the drain pump filter.
- Be careful of hot water. Allow the water to cool down. Risk of scalding!
- Clean the filter periodically every 3 months to ensure the normal operation of the appliance.

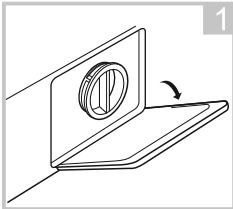

Open the lower cover cap

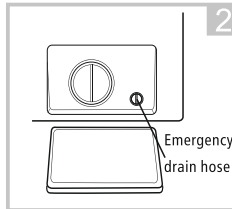

Rotate 90° and pull out the emergency drain hose, and take off the hose cap

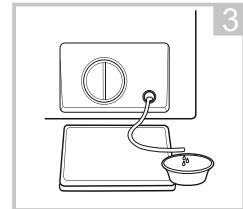

After water runs out, reset the drain hose

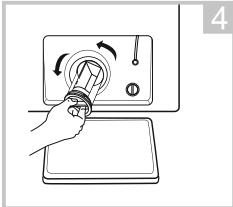

Open the filter by turning to the counter clockwise

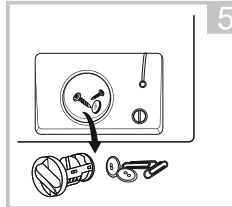

Remove extraneous matter

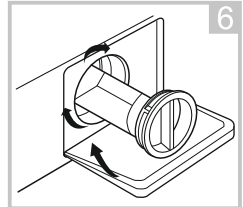

Close the lower cover cap

⚠ Caution!

- Make sure that valve cap and emergency drain hose are reinstalled properly, cap plates should be inserted aligning to hole plates otherwise water may leak.
- Some machines don't have emergency drain hose, so step 2 and step 3 can be skipped. Rotate lower cover cap directly to make water run into basin.
- When the appliance is in use and depending on the programme selected there can be hot water in the pump. Never remove the pump cover during a wash cycle, always wait until the appliance has finished the cycle, and is empty. When replacing the cover, ensure it is securely re-tightened.

MAINTENANCE

■ Trouble Shooting

Whenever there is a problem with the appliance, check if you can solve it following the tables below. If the problem persists, please contact the customer service.

Description	Possible cause	Solution
Appliance does not start	Door is not closed properly. Clothes are stuck.	Close the door properly and restart. Check the laundry.
Door can't be opened	Safety protection is activated.	Disconnect the power and restart.
Water leakage	Connections are not tight enough.	Check and fasten the water inlet pipe. Check and clean the outlet hose.
Detergent residues in the detergent dispenser	Detergent is damp and/or clotted.	Clean and wipe the detergent dispenser dry.
Indicator or display does not work	PC board or harness have connection problems.	Switch off the power and check if the mains plug is connected properly.
Abnormal noise	Fixing bolts still in place. Floor is not solid or level.	Check if the fixing bolts have been removed Make sure the appliance is installed on a solid and level floor.

Error Codes

Description	Possible cause	Solution
E30	Door is not closed properly	Close the door properly and restart.
E10	Water injecting problem during wash cycle.	Check if the water pressure is high enough. Straighten the water pipe. Clean the inlet valve filter.
E21	Overtime water draining	Check the drain hose for blockage.
E12	Water overflow	Restart the appliance.
EXX	Others	Restart the appliance. If problem persists, please contact the customer service.

WARRANTY

A. Warranty Period:

Havells India Ltd. (Company") hereby offers a limited warranty ("Warranty") for its Lloyd branded Washing Machine ("Product") against manufacturing defect/s for a period of 24 months (Two Year) from the date of invoice on the terms and conditions provided hereinafter.

B. Warranty Terms & Conditions:

1. To claim Warranty, it is mandatory that the customer provides the original invoice and wherever possible original Warranty certificate (duly signed and stamped by the selling dealer) must be presented by the customer.
2. To claim warranty service, customer needs to log in his complaint with the customer care cell.
3. This Warranty is limited to the first purchaser of the Product only.
4. This Warranty is valid and applicable only in respect of the Product purchased in India only.
5. This Warranty cannot be clubbed with any promotional limited warranty scheme prevalent on the date of the invoice unless specifically provided for in any special Warranty schemes.
6. To avail any Extended/Additional Warranty provided by the Company, customer should comply with the Product registration and other Terms and Conditions of the Extended/Additional Warranty as available on the website- www.mylloyd.com.
7. The Warranty period specified above shall include the period when the Product is not in use, time taken for repairs, replacements, breakdowns, transit time, etc. No notice of expiry period of Warranty will be given by the Company.
8. It is clarified that after one year from the date of invoice, Company's responsibility to continue to provide additional Warranty services in terms as agreed upon shall however be limited only to supply of the parts free of cost and any cost(s) incurred towards labor, transportation and any other incidental expenditure for providing the said Warranty services shall be borne by the customer
9. The decision to repair or replace any part of the product shall be at the sole discretion of the Company. In the event of repairs or replacement of any part carried out during the said Warranty Period, the Warranty shall thereafter continue only for the unexpired period of the Warranty.
10. In the event, the Product is not serviceable or repairable during the Warranty Period due to technology upgrades, obsolescence of technology, discontinuance of Product/part and/or reasons beyond the control of the Company, the Company will replace the Product with the then prevailing equivalent/upgraded Model. In this event Customer will be liable to pay the differential amount between the market value of the new Product and depreciated value of customer's old Product as ascertained by the Company. Depreciation will be charged only after first year from the date of purchase.
11. If repair or replacement of component/part is rendered illegal because of subsequent law changes, Company will have no responsibility for procuring replacement parts if doing so would be commercially impractical.
12. To avail Warranty services for the Product, any recommendations made by the Company's visiting Authorized Service Representative shall be complied by the customer and if that recommendation requires repair of any electrical installations, wiring or of any third party product attached to the Product, it shall be first undertaken by the customer at his entire cost. Thereafter, the Warranty for the Product can be availed.
13. Company shall not be held liable or be deemed to be in default for any delay or failure in performance resulting directly or indirectly from causes beyond its reasonable control including delay in repairing due to non-availability of any component or accessory, labor problem, restrictions and regulations of the government, public movement, war and any unavoidable circumstances, specially vis-a-vis the import of supplies and raw material.
14. In case of any request to change the location where the Product has been initially installed during the Warranty, the customer will log in a request with customer care cell to ensure that the dismantling / inspection of the Product is done by Company's Authorized Service Representative at the existing location. Thereafter the customer shall transport the Product to the new location at his own cost and consequences for re-installation of the Product. The customer shall again log in the request with customer care cell for such re-installation which shall be undertaken by Company's Authorized Service Representative. Such dismantling and re-installation, undertaken during the Warranty period shall be done on chargeable basis. Any damage to the Product caused on account of such transit shall be at customer's cost and risk and Company shall not be held responsible in any manner whatsoever.

15. In case of any additional warranty offered by the Company on the Motor on the date of purchase/invoice, the Company shall be responsible to only supply the motor free of cost to the customer and any cost(s) incurred towards labour, transportation, & any other incidental expenditure shall be borne by the customer.
16. The Warranty provided herein is in lieu of implied conditions and warranties under the law and is confined to the repair or replacement of defective parts and does not cover any economic loss, commercial loss, consequential or resulting liability, damage to the property, or any other harm or loss.
17. None of the employees and /or Authorized Dealers of the Company have any authority whatsoever to vary the terms and conditions of this Warranty.
18. In the event that any terms and condition of this Warranty becomes invalid and/or unenforceable, the remaining terms and provisions hereof shall continue in full force and effect.

C. Exclusions to Warranty:

- If the Product is serviced, repaired, installed, de-installed, dismantled or otherwise attended to by any person other than the Authorized Service Representative of the Company.
- If customer violates Warranty Terms and Conditions, instruction manual guidelines, recommendations of Authorised Service Representative and/ or operates the Product otherwise than as per Product specifications.
- If the original serial number on the Product or any part thereof is damaged, defaced, obliterated or erased/ tampered with or if Product is refurbished/modified for any reason whatsoever.
- If the Product is operated in conditions otherwise than normal conditions (e.g., abnormal voltage surge, extreme heat, corrosive/alkaline/acidic atmosphere, dust ,damage from sea water, pollution ,chemical environment ,sulfur in the air, installation near the open drainage system etc.).
- If the Product is used for any commercial purpose.
- Any harm caused due to accident, negligence, improper maintenance, mishandling, tampering, incurred in transit by the customer or which can be attributed to the fault of the customer.
- Any harm resulting from any unforeseeable circumstances such as force majeure event etc.;
- Any harm caused due to any defect in any electrical/civil installation(s), wiring or third party products.
- Any liability resulting from any un-authorized adaptations or adjustments to the Product or due to usage of a third party apparatus or equipment.
- Any damage to the Product due to household pets, rodent or any other insect/animals.
- External parts, accessories and plastic parts of the Product;
- Normal wear & tear of parts.

Havells India Ltd.
Warranty Registration Card (Washing Machine)
Service Centre Copy

Customer Details

Title: Mr Ms Mrs M/s
 Name: _____
 Residence Address: _____
 Dist: _____ Pin: _____
 State: _____ Occupation: _____
 Tel: (____) _____ Res: (____) _____ Fax: _____
Code Code
 Mobile No: _____ Email: _____

Product Details - Washing Machine

Model No: _____
 Serial No: _____
Please Refer Sticker On Back Cover Of Your Product
 Purchase Date: _____
Day Month Year
 Bill No. _____

Dealer's Name & Address
Signature

I Accept the Terms and Conditions of the Warranty Customer Signature

Thank you for selecting a World Class product and we assure you that it will perform as per your expectations.
 We thank you for taking your time to complete this form. All Information Provided by you will be Kept Confidential.
 (Please Fill In, Tear off, Fold and Mail this form to Reach us within 10 days of the Product Purchase.)
We welcome your Valuable Suggestions, if any, to Improve our Products and Services :

FOR OFFICE USE ONLY

Customer Code: _____
 Branch: _____

Note: Company Will Not Be Responsible For The Loss Of This Form During Transit. Havells India Ltd.

Havells India Ltd.
Warranty Registration Card (Washing Machine)
Customer Copy

Customer Details

Title: Mr Ms Mrs M/s
 Name: _____
 Residence Address: _____
 Dist: _____ Pin: _____
 State: _____ Occupation: _____
 Tel: (____) _____ Res: (____) _____ Fax: _____
Code Code
 Mobile No: _____ Email: _____

Product Details - Washing Machine

Model No: _____
 Serial No: _____
Please Refer Sticker On Back Cover Of Your Product
 Purchase Date: _____
Day Month Year
 Bill No. _____

Dealer's Name & Address
Signature

I Accept the Terms and Conditions of the Warranty Customer Signature

Thank you for selecting a World Class product and we assure you that it will perform as per your expectations.
 We thank you for taking your time to complete this form. All Information Provided by you will be Kept Confidential.
 (Please Fill In, Tear off, Fold and Mail this form to Reach us within 10 days of the Product Purchase.)
We welcome your Valuable Suggestions, if any, to Improve our Products and Services :

FOR OFFICE USE ONLY

Customer Code: _____
 Branch: _____

Note: Company Will Not Be Responsible For The Loss Of This Form During Transit. Havells India Ltd.

E-WASTE DISPOSAL

Environmental Compliances:

As per the rules laid down by the Government for environmental concern & safety, your product has been made to comply and conform to the respective regulation as listed below. This product falls under the E-WASTE (MANAGEMENT) RULES, 2022 with all amendments of Ministry of Environment, Forest & Climate change.

RoHS Declaration:

This Product is in conformity with requirements of Rule 16 of the E-WASTE (MANAGEMENT) RULES, 2022 with all amendments. The content of hazardous substances with the exemption of the applications listed in SCHEDULE II of the E-Waste (Management) Rules, 2022 with all amendments is as follows:

- Lead (Pb): not over 0.1% by weight;
- Mercury (Hg): not over 0.1% by weight;
- Cadmium (Cd): not over 0.01% by weight;
- Hexavalent Chromium (Cr6+): not over 0.1% by weight;
- Polybrominated Biphenyls (PBBs): not over 0.1% by weight;
- Polybrominated Diphenyl Ethers (PBDEs): not over 0.1% by weight.

Do's and Don'ts for disposal of product:



1.) Do's:

- Always drop your used electrical/electronic products, defective spares or any accessories and packaging materials after the end of their life at the nearest authorized collection point/center.
- Make sure that your electronic products are recycled only by authorized recyclers/dismantlers.
- Segregate the packaging materials according to their respective waste disposal options and sorting for recycling.
- Protect the glass surface of any electronic product to avoid breakage.

2.) Don'ts:

- Never dismantle your electronic product yourself.
- Never sell or give E-Waste to informal and unorganized sectors like local scrap dealer/rag pickers.
- Never dump E-Waste in garbage bins or municipal solid waste stream.
- Do not dispose your product as unsorted municipal waste.

For more information on safe disposal, recycling and collection point, please call customer care number 0804-577-5666

or visit our website : <https://havells.com/e-waste-awareness>
or write a mail to ewaste@havells.com

LLOYD

Havells India Ltd.

Registered Office: 904, Surya Kiran Building, K.G. Marg, New Delhi - 110001 (INDIA)

For Consumer Complaint, Contact: Manager, Address: Same as Regd. Office.

Customer Care Number: 0804-577-5666

Email: customercare@havells.com