

Operating Instructions



Instantaneous Gas Water Heater
Flagro 6L & 8L



Dear Customer,

We congratulate you on choosing a **HAVELLS** Instantaneous Gas Water Heater, one of the highly prestigious brand in India.

Meticulously designed, using only the highest quality materials and components, your electric water heater is designed to have many years of trouble free operation.

To enable your electric water heater to give you many years of perfect trouble free service, we recommend you to follow the advice contained in this Instruction manual very carefully.

Parts name & Structure for Flagro 6L:

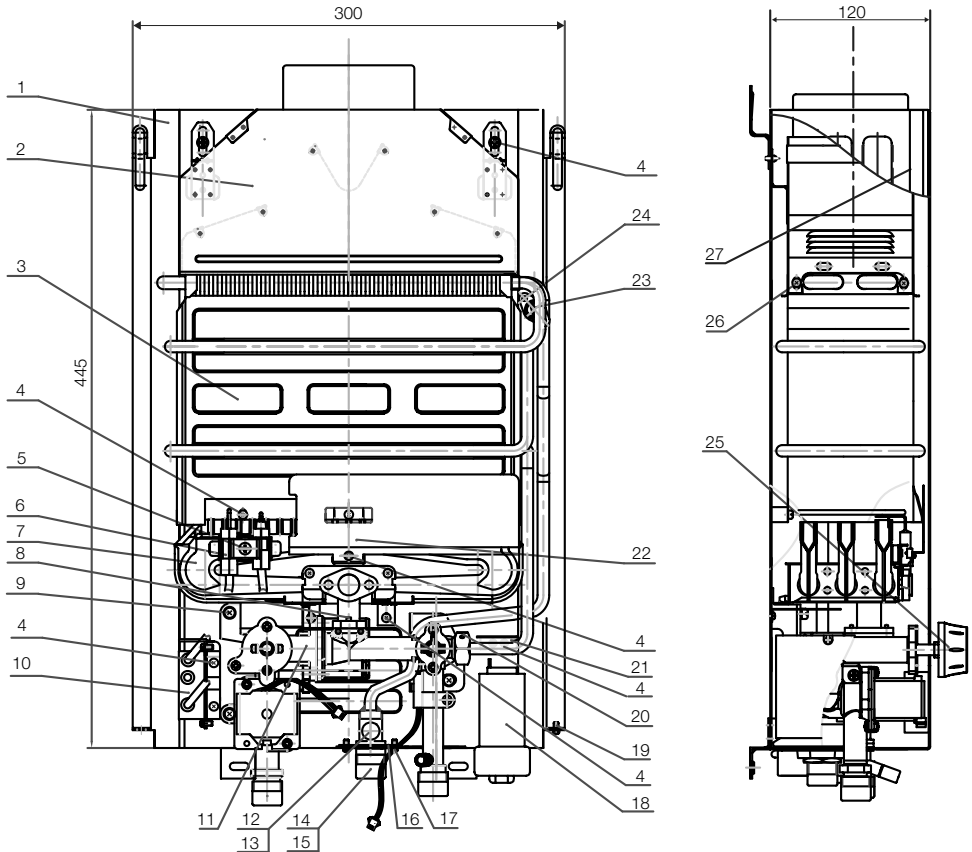

1	Back cover assembly
2	Drought diverter
3	Heat Exchanger
4	Screw (M4*6)
5	Screw assembly (M4*14)
6	Needle fixing plate
7	Burner assembly NG/LPG
8	Screw assembly (M4*12)
9	Screw (M5*12)
10	Pulse ignition system
11	Gas & water valve NG/LPG
12	Temperature detector
13	Seal ring
14	Dustproof cover

15	Gasket
16	Water outlet fixing plate
17	Screw (M4*8)
18	Battery box
19	Screw (M4*8)
20	Water tube seal ring
21	Heat shield
22	Heat insulation shield
23	Thermostat
24	Screw (2.9*6)
25	Water & gas knob
26	Screw (4.2*8)
27	Front cover assembly

Features:

Product features -Safety

- 1) Auto Ignition: Simply open the water valve & the impulse will ignite automatically & hot water immediately available.
- 2) Water temperature regulation: regulate the water temperature at any temperature.
- 3) Child Lock: This Ensures safety to children / old age people by preventing ignition if operated unsafe.
- 4) LPT: Low start up water pressure with a broad scope of application.
- 5) Flame Failure protection: The water heater will automatically cut off the gas in case flame goes out during use.
- 6) Auto shut off: The water heater will automatically shut down when water supply is stopped.
- 7) PRV: When the pressure of incoming water supply is too high, the safety valve of the water heater can automatically relieve pressure to avoid any damage to the water heater.
- 8) Thermal Protection: The water heater will automatically cut off the gas & stop working when the temperature of the water flowing out from the water heater exceeds 95°C or dry burning occurs.
- 9) 20 Minutes timing protection: The water heater will automatically cut off the gas & power off after a 20 minutes continuous operation. At this point Customer need to just turn off & turn it on Again.
- 10) Double solenoid Valve.

Convenience:

- 1) LED Temperature Display: 7 Segment Display readily indicates outlet water temperature.
- 2) Slim Design

Parts name and Dimensions:

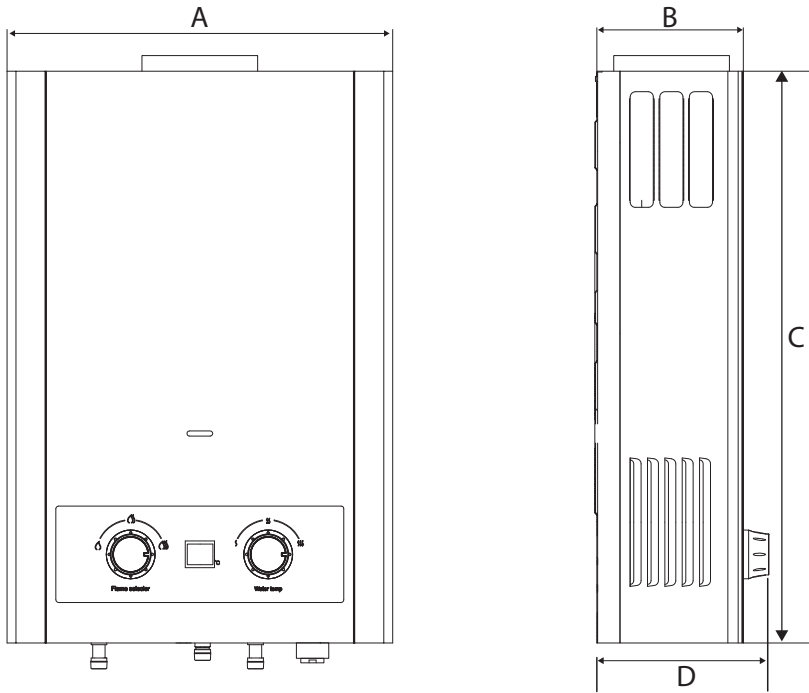

Model	A	B	C	D	E
Flagro 6 L	300	120	445	140	G ½"
Flagro 8 L	332	159	498	179	G ½"

Note: All dimensions are in mm, dimensions tolerance ± 5 mm

Technical Specifications:

Name	Gas-fired instantaneous Water Heater	
Model	Flagro 6L	Flagro 8L
Rated Heat Load	12 kW	16 kW
Max Flow Rate (rise 25°C)	6kg/min	8kg/min
Water Pressure	0.01~1.0MPa	
Gas Pressure	LPG 2940Pa	
	NG 2000Pa	
Pipe Joint	Gas Inlet	G ½"
	Cold Water Inlet	G ½"
	Hot Water Outlet	G ½"
Flue Duct Diameter inner diameter	Ø90 mm	Ø110 mm

(The above table is for reference only. Please refer to the name plate for the final technical parameters.)

WARNING:

1. Read the technical instructions before installing the appliance.
2. Read the user's instructions before lighting the appliance.
3. This appliance shall only be installed outside.
4. This appliance may only be installed in a room if the room meets the appropriate ventilation requirements.

Installation:

Before installation, please contact the qualified technicians and ensure that Installation is approved by the local gas authority.

Installation Requirements:

The room for installation should be well ventilated.

Do not install the water heater in bedroom, basement, bathroom, or rooms with bad ventilation condition. A ventilation hole as well as an exhaust hole must be drilled in the wall, connected to the outside. The exhaust fan shall be installed overhead of the water heater, and the venting hole shall be at the level lower than the water heater. (Fig.3)

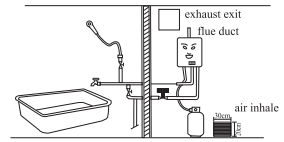

Fig.3

The flame-check window of the water heater shall be at the level of eyes (about 1.55m-1.65m above the floor. Fig.4), kept away from Inflammables(Fig.5). No lines or electric equipment could be put overhead of the water heater. The heater shall be kept at least 400mm far from any electrical equipment.

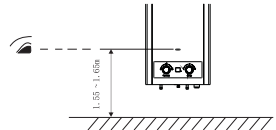

Fig.4

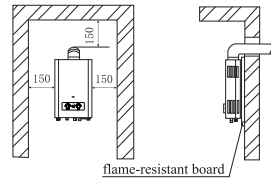

Fig.5

Do not install the water heater where strong wind blows, or it can cause flameout or incomplete combustion.

Installation Method:

1. Installation

Unit must install in verticle position.

Drill holes in the wall according to Fig.6, put an expansion bolt into the above hole and plastic gasket into the below hole, and then mount the water heater vertically on the above bolt without inclination and tighten the below holes with expansion bolts.

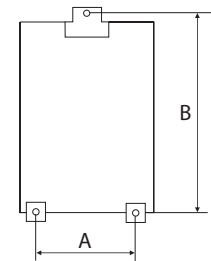

Fig.6

2. Piping

Recommended to use regulator ISI marked.

Put the gas Inlet Nipple(Supplied with the unit)to the gas inlet of unit and connect the gas pressure regulator of the gas cylinder by using ISI marked rubber tube with diameter of 9.5 mm after fasten the joints with clips, check the connections with soap solution for leaks.

Model	A	B
Flagro 6 L	175	464
Flagro 8L	246	513

Water Inlet Faucet

It's suggested to use the tube provided, or you may use rigid pipe as cold-water connection. A water controller shall be installed before the water inlet faucet (Fig.7). (Note: There is a filter inside the water inlet faucet, so please do not remove it while installing).

Hot Water Outlet may be connected to a tap or shower by either a flexible pipe or rigid pipe.

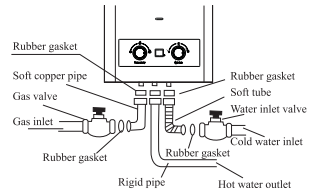

Flagro 6L

3. Battery Installation

Do not confuse the positive and negative ends of the batteries (See Fig.8).

4. Flue Duct Installation

As this water heater is flue duct type, the waste air exhaust pipe must be installed not provided with the unit (Fig. 9). Detailed requirements are as follows:

The main body of the flue duct shall be made from rustproof material.

The horizontal part of the flue duct shall have a 1% down inclination, and there shall be a 10mm hole at the bottom of the vertical part of the duct outside the room, for the purpose of draining water drops

The outlet of the flue duct shall have a windproof cap, which should not be clogged.

Installation method:

Drill proper holes on the wall according to the dimensions of the heater refer Fig.9 for dimensions and layout of the flue pipe installation.

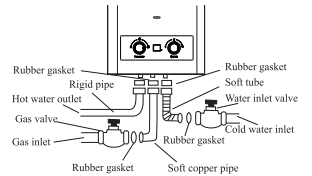

Fig.7

Flagro 8L

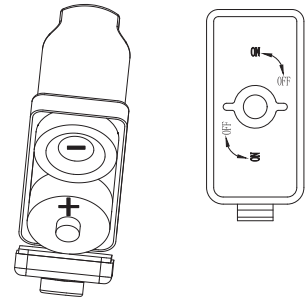

Fig. 8

Operation Method

1. Preparation before Ignition

Make sure the gas type used complies with what stipulated in the label.

Open the ventilation holes and turn on the exhaust fan.

Turn on the gas inlet valve.

2. Ignition

Turn on the water valve (make sure there is water flowing out of the shower), and then the water heater with "clicking" ignition sound. The burner is ignited and hot water flows out instantly. If the water pressure is lower than the one shown on nameplate, or the gas

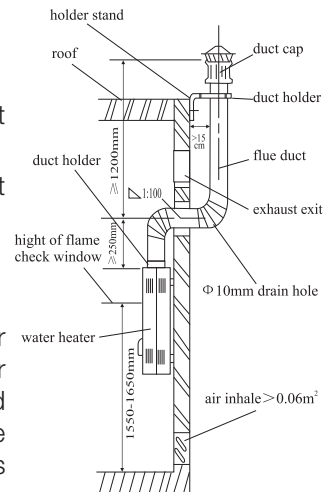

Fig.9

is not connected, the water heater will not operate normally.

After initial installation or change of gas cylinder, air may remain in the gas pipe and it requires several ignition attempts to push the air out before the gas can be ignited. If a problem comes up after normal operation, turn off the water immediately. Try to re-ignite 10-20 seconds.

3. Water flow Control

Turn the water flow valve to control the water flow & therefore the temperature.

Turn the gas regulator tap to control the flame of the burner thus controlling the hot water temperature.

Turn the water inlet tap to control the water temperature: decreasing the water flow to make the water temperature higher (Please adjust it slowly, if the flame extinguished then re-ignite before increasing the water flow), and increasing the water flow to make the water temperature lower.

Turn off the hot-water outlet valve and the water heater will stop working automatically.

Test water temperature with your hand before shower, so as to avoid scalding. (Fig.10)

Turn off the gas valve after use. (Fig.11)

During winter season, the water heater must be drained after each shower as follows:

Turn off the water control valve.

Turn the water flow control knob to "low" position.

Remove the drain cock. (The drain cock is a bolt connected to the valve. Take it off by counter-clockwise to drain the water out completely). Fix the drain cock back into the original place for another shower.

Cautions for Safety

Check whether the flame is extinguished after each use and do not forget to turn off the gas valve (Fig.11)

Always check all the gas pipe connections with soapsuds to see whether there is any gas leakage. In case of gas leakage, please shut off the gas supply and open the windows immediately. Under such condition, actions such as ignition, switching on/off

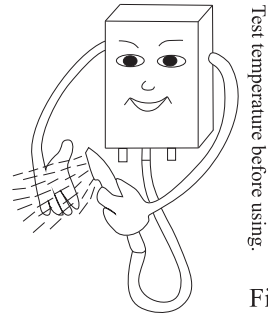

Test temperature before using.

Fig.10

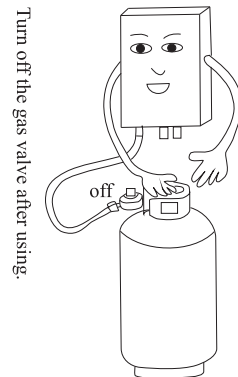

Turn off the gas valve after using.

Fig.11

the electric power supply are strictly prohibited to avoid explosion and fire. (Fig.12)

Keep on using one type of gas (L.P.G or NG), never mixing using them.

Check the gas tube regularly in case of aging or crack after long period of usage. Replace it if cracked tubes are found. The gas tube should be replaced yearly with normal use.

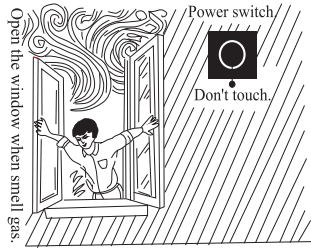

Fig.12

For LPG users, if the flame of the heater is not stable, it may be caused by the breakdown of the pressure reduction valve connected to the outlet of the gas tank. In that case, stop using the heater immediately and contact a service technician.

For NG users, if the flame of the heater is not stable, it may be caused by the instability of the gas pressure. In that case, stop using the heater, otherwise it may cause damage or even cause accident.

Fire Accident Prevention

Make sure that the flame of the heater has extinguished before leaving the room or go to sleep.

Turn off the main gas valve and the water inlet valve in case of water shortage.

Do not place inflammables like towel or cloth onto the water air drain outlet or the air inlet.(Fig.14)

Do not pile inflammables, explosives or volatile materials near the heater. (Fig.13)

For LPG users please do not place the tank overhead or inverted, otherwise the liquid in the gas cylinder may flow back into the heater, and cause fire accident.

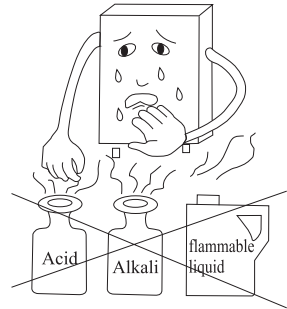

Fig.13

Carbon Monoxide Intoxication Prevention

The burning of gas consumes large amount of air and produces some amount of poisonous gas like carbon monoxide. Thus, the heater must be fixed in a ventilated location. Keep exhaust fan running and the ventilation hole opened.

As this water heater is large volume flue type, the flue duct must be installed to drain the combustion product out of the room, keeping the air inside the room clean.

TG or NG users must pay attention to the flame-back

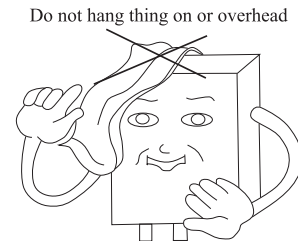

Fig.14

phenomenon when the gas pressure is insufficient. This causes increase of the carbon deposit in the burner and affect the normal use of the heater. In such case, should the flame turn from blue to yellow, the amount of carbon monoxide would increase. Stop using the heater and contact the gas company or the service center.

The heater must be installed vertically.

Prevent Eyes from Getting Hurt

Keep eyes away from the flame indicator window at a minimum safety distance of 300mm during ignition. If the first attempt of ignition fails, wait 10-20 seconds before the next attempt.

Prevent No-Water Burning in The Heater

After each shower, make sure that the flame is extinguished when the valve is closed. If the flame still exists after the water valve is closed, something must be wrong with the heater. Switch off the gas valve immediately and contact the service center. Otherwise the heater may be damaged by overheating and then may cause fire accident.

Freezing Prevention

Under the circumstance of low temperature, please drain the water remaining in the heater completely after each use. Otherwise the water may freeze and cause damage the heater.

Reduce The Chance of Getting Furred

After shower, please turn off the gas valve and drain out the hot water in the gas cylinder until cool water is out. Then turn off the water inlet valve.

Do Not Use The Heater Water for Drinking

As there is always gas residue present in the heater, the water supplied by the heater is only for general usage, not for drinking.

Dealing With The Abnormal Conditions

Stop the heater when there is strong adverse wind blowing into the bathroom from outside causing the heater unable to operate.

In case of abnormal burning (e.g. flame-back, flameout, yellow flame or black smoke, etc.), unusual smell, noise or other abnormal situations, keep calm and turn off the gas valve and contact the service center or the gas dealer.

Preventing Overheating Scald

After shower, or when the water temperature control knob is still at “high” position, be careful of the temperature of the water at the beginning and the end of shower, as the water temperature may remain high to scald your skin.

During or right after shower, do not touch any part of the heater except the control knobs, especially the parts around the flame check window.

The following phenomenon are normal:

The drain valve is dripping. When the water pressure is too high, the drain valve will release water so as to reduce the pressure to protect the heater.

When the heater is supplying hot water to too many points at the same time, the hot water flow would be reduced, and under exceptional circumstances no hot water will come out at all.

During shower, if the heater is operated for more than 20 minutes, the flame will automatically turns off due to the 20-minute timer safety protection function.

Maintenance

Check the gas tube/pipe regularly for any defect. Contact service center for any doubt.

Clean the water filter regularly.

Check the water leakage regularly.

When the flame turns from blue to yellow with black smoke, contact the service center immediately for help.

Every half year contact qualified professionals to check whether the heat exchanger and burner are clogged.

Always keep the cover of the heater clean.

Hard water can cause scaling due to which water flow & Temperature may fall over a period of time.

Do's

- 1) Ensure proper Ventilation while gas water heater in use.
- 2) Use genuine spare parts & connecting Pipes.
- 3) Switch off the water heater after use.
- 4) Ensure no leakage in Water & Gas Pipe after Installation.
- 5) Install in vertical position only.
- 6) In case LED display does not show temperature, do not start the unit. Replace the batteries and if still not working, please contact the nearest customer care through Toll Free No (18001031313).
- 7) Ensure use of proper Gas as mention on product (LPG / NG).
- 8) Check the gas pipe regularly for aging, Cracks etc. (Preferably use "SURAKSHA " ISI mark connection pipes for gas connection where required)

Don'ts

- 1) Do not install product in bathroom that don't have ventilation
- 2) Do not place anything near flue outlet.
- 3) Do not stack inflammables near heater.
- 4) Avoid Commercial regulators.

Item Names	Quantity
Water Heater	1
Mounting Screws	2
Users' Manual	1
Gas Inlet Connection (With Rubber Seal Gasket)	1
Expansion Bolts (M6)	1
Expansion rubber plug	2

Trouble Shooting:

Troubles Reasons		The flame goes out	No ignition after opening Water valve	Bumpy noise in ignition	Yellow flame	Abnormal smell	Low temperature of water at "max."	High temperature of water at "max." position	Burning after closing the water valve	Solutions
Gas valve not open			•							Turn on main valve or replace the gas
Gas valve half open		•					•			Turn on the main valve
Air in the gas pipe			•							Open several opening the water inlet valve until ignition
Unsuitable Pressure Gas	High		•							Contact the service center to check the gas pressure valve
	Low	•					•			
Cold water valve closed			•							Turn on the water supply main valve
Freezing			•							Use after de-frozen
Inadequate water supply		•	•					•		Clean filter or contact service center
Water temperature control mistake									•	Turn the temperature and gas rods properly
Insufficient fresh air		•				•				Open the ventilation hole to let enough fresh air in
Power shortage		•	•							Replace the batteries
Burner clogged					•	•				Contact the service center
Heat exchanger clogged		•			•	•				Refer manual
Water control unit failure		•	•				•	•		Refer manual
Ignition needle movement			•	•			•	•	•	Refer manual
Continuous 20 minutes operation		•								Re-ignite for use if the ventilation is good

Warranty

This Water Heater carries 2 years comprehensive warranty on instantaneous gas water heater from the date of purchase against manufacturing defects. Free repair will be provided under the warranty period when the Water Heater is returned to our Service Centre, freight and cartage paid.

This warranty only applies if:

- a) The water heater has been installed as per instruction manual.
- b) Maintenance has been carried out as instructed.
- c) Safety valves have been kept in right working conditions.

The warranty is void if:

- a) The cooper pipes has been damaged by external causes. Damages due to misuse, accident, negligence, un-authorized repair or alteration or modifications or incorrect use of the water heater & normal wear & tear.

Please preserve this warranty card along with paid bill/invoice from the dealer while making purchase. These documents must be presented to the service centre or to the dealer to avail this warranty.

Customer Name _____ Model No.: _____

Serial No. _____

Invoice No.: _____

Date of Purchase: _____

Dealer's Name, Address:

Dealer's Seal & Signature

REGIONAL & BRANCH OFFICES:

NORTH - REGIONAL OFFICE: Corporate Office: QRG Towers, 2D, Sector-126, Expressway, Noida-201304, Tel: 0120-3331000, **Delhi:** Tel: 011-47676700, 23888200, **Chandigarh:** Tel: 0172-4232400-401, **Dehradun:** Tel: 0135-6670202, **Noida / Haryana:** Tel: 0120-3331000, **Ludhiana:** Tel: 0161-4676000 / 24, **Jammu:** Tel: 0191-2478330, 2479330, **Sri Nagar:** Tel: 0194-2490431, **Jaipur:** Tel: 0141-3914645, 3988210 **Jodhpur:** Tel: 0291-9214201640 / 45, **Lucknow:** Tel: 0522-6672100, **Kanpur:** Tel: 0512-6710400, 6710409

EAST - REGIONAL OFFICE: Kolkata: ICC Tower, 5th Floor, 4 India Exchange Place, Kolkata-700001, Tel: 033-40129851/ 52, **Bhubaneswar:** Tel: 0674-6668101/102/103/104, **Guwahati:** Tel: 0361-2134521, 2458923, 2460355, **Siliguri:** Tel: 0353-2525907, **Ranchi:** 0651-2244861, 2244862, 2244864, 2244868, 2244869, **Jamshedpur:** Tel: 0657-6542492, 09234369436, **Patna:** Tel: 0612-2207221, 2207222, 2207223, 2655518

WEST - REGIONAL OFFICE: Mumbai: 1271, Solitaire Corporate Park, Bldg. No. 12, 7th Floor, Andheri - Ghatkopar Link Road, Chakala, Andheri (East), Mumbai- 400093. Ph.: 022 - 67298600-602, **Ahmedabad:** Tel: 079-40061111, 40060738-740, **Indore:** Tel: 0731-2572340-41, 4009998 (Airtel), **Rajkot:** Tel: 0281-2481112, 2921212, **Nagpur:** Tel: 0712-2240932, 2242692, 2242699, **Pune:** Tel: 020-64016413 / 14, **Raipur:** Tel: 0771-4243400 / 01, **Surat:** Tel: 0261-2350137, 9979890137, **Jabalpur:** Tel: 0761-4064491

SOUTH - REGIONAL OFFICE:

Chennai: Sigapi Achi Building, No. 18 / 3, 6th Floor, Rukmani Lakshmiipathy Road, Egmore, Chennai-600008, Tel: 044-42280600, 605, **Bangalore:** Tel: 080-49075000, **Coimbatore:** Tel: 0422-4550200, 2305199, 2306199, **Hyderabad:** Tel: 040-27533372, 27533355, 27533632, 66320407/0408/6401/6402, **Kochi:** Tel: 0484-4099000, **Vishakapatnam:** Tel: 0891-6514339, **Vizag:** Tel: 0891-6514339, **Vijayawada:** Tel: +91-9247058847/57, **Calicut:** 0495-4019194, **Madurai:** 0452-4267022, **Trivandrum:** 0471-4015323, **Hubli:** 0836-4248600, **Trichy:** 09944460160

Representative Offices: • Goa • Solapur • Gwalior • Kathmandu • Bhopal

Havells India Ltd.

Corp Office: QRG Towers, 2D, Sector-126, Expressway, Noida-201304 (U.P) Ph. +91-120-4771000
Email : marketing@havells.com, www.havells.com
Consumer Care: 1800 11 0303, 1800 103 1313 (All Connections), 011-4166 0303 (Landline)
Join us on Facebook at www.facebook.com/havells
and share your ways to save the planet !
CIN - L31900DL1983PLC016304

