

# Operating Instructions



*Elio*  
**PRIME SMART**



**HAVELLS**

## PACKAGE CONTENTS

In the box check for following items :

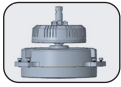

Motor

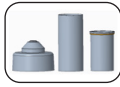

Canopy Set

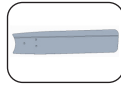

Blade Set

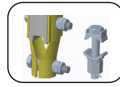

Shackle Kit

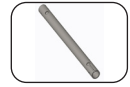

Down-rod



Twisted wire



Battery (AAA)  
2 N



Remote

### Remote Pairing:

**NOTE:** Remote supplied along with fan is already paired with your fan.  
Follow below pairing instructions if your fan remote or PCB is changed.

Following steps have to be executed in correct sequence and all steps should be done within 10 seconds total.

1. Power ON fan, from the main supply.
2. Press the  OFF button on the remote once.
3. Press the Fan Speed 1 button on the remote once.

**Successful pairing will be confirmed by two beeps from the Fan.**

**Note: If pairing fails repeat the steps after powering OFF the fan from the mains.**

### Un-Pairing Instructions

To un-pair the unwanted remote, repeat the complete pairing process two times on the remote you want to keep using, with a minimum 1 minutes time between first and second pairing. The unwanted remote will be automatically unpaired.

### Fan Installation:

Blade Installation (Figure 1, 2)

1. Unscrew the blade screw from motor & align the blade slot with the three lugs in motor.
2. Screw blades with motor and ensure tight fit. Balance the blade by lifting it slightly upwards from tip end before tightening.
4. Ensure all Blades have the same numerical code mentioned on blade sticker, for precise balancing of fan.

**IMPORTANT :** While tightening the blade screws on motor, ensure that blade profile not damaged.

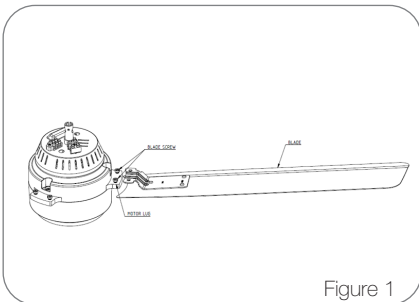

Figure 1

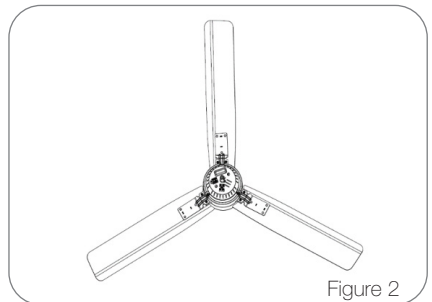

Figure 2

## FAN INSTALLATION

For installation of Fan with downrod, the following instructions and methods are to be followed.

1. Remove the downrod cap from downrod and slide the bottom canopy over the downrod and then slide top canopy from top side (Figure 3).
2. Pass the Power supply & earthing wires (to be installed by customer at their end) through the downrod from top side holes and pull the wires from slit hole of the downrod.
3. Remove the split pin, hex nut, lock nut, spring washer, aluminium spacers from the bolt assembly supplied with the shackle assembly (Figure 4). Remove the safety/earthing screw on the shaft and keep it securely
4. Slide the downrod (from split end side) over the shaft. Align the cross holes on the downrod and the shaft.
5. Now use one Aluminium spacer on each side of the down rod for gripping and insert the bolt, place the spring washer and tighten the hex nut and the lock nut and tighten them fully, holding the bolt head with a spanner.
6. Ensure that this bolt is fully tighten. Insert the split pin and separate the projected ends.
7. Fix the earthing wire to safety/earthing screw and tighten the safety screw to shaft over down rod which was removed previously
8. The shackle assembly provided has hex bolt with hex nuts, lock nuts and split pins. When hanging the fan on the hanger the hex bolts should be securely tightened with hex nuts & lock nut.
9. The split pins should be securely replaced in their place as shown in, assembled and exploded views (Figure 3 & Figure 4)

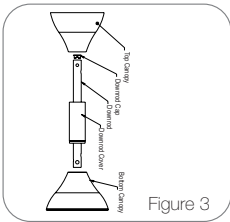

Figure 3

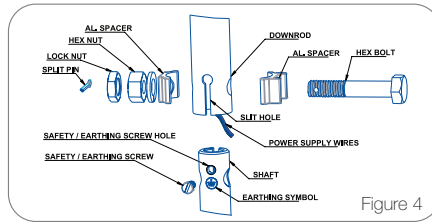

Figure 4

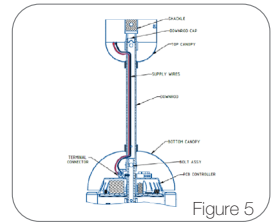

Figure 5

### Internal Wiring Connection (Figure 5):

1. Connect the Power supply wires (1 N) to the Terminal Connector.

### For Installation of Fan with Ceiling Hook:

Steps to mount fan on ceiling hook as shown below:

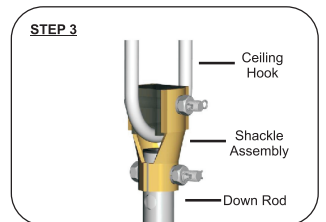
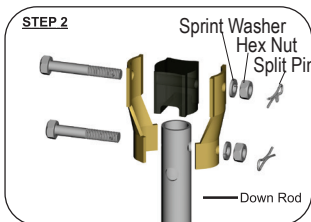
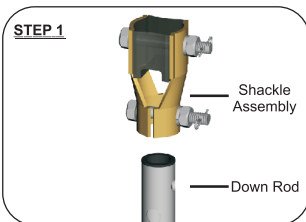

### Installation Guideline for Better Performance:

- To optimize the Air delivery, ceiling fan should be approx. 3 m from the Ground level and 30.5 cm below the ceiling.
- Remote Maximum Range in all direction is 3 m (with good battery condition) This range may vary if there are obstructions between remote and fan.
- Keep Minimum (80 cm ~ 1.2 m) distance b/w blade tip and side walls.

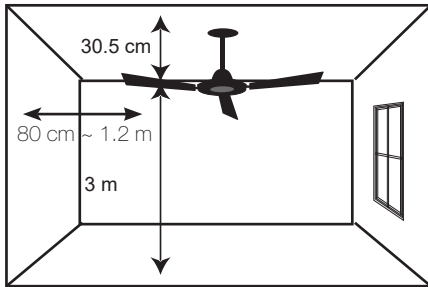

### Selection Guide:

Ceiling Fan recommended sweep for different room sizes

Model Size	Sweep / Size (mm)	Suitable for room size
Ceiling fan	600 mm	For Small Shops, Cabins & Toilets
Ceiling fan	750 mm	1.8 m x 3.0 m
Ceiling fan	900 mm	2.1 m x 3.0 m
Ceiling fan	1050 mm	3.0 m x 3.0 m
Ceiling fan	1200 mm	3.6 m x 3.9 m
Ceiling fan	1250 mm	3.8 m x 4.2 m
Ceiling fan	1400 mm	4.2 m x 4.8 m

### KEY FEATURES:

IOT Control with Mobile App

Access your Ceiling Fan remotely using iOS / Android™ App on your smartphone.

#### Sleep Mode

Fan reduces speed level at fixed interval

1. If fan is running at SPEED LEVEL 5 then speed will reduce one level at 90 minutes interval till 1st speed and continuously run at 1st speed.
2. If fan is running at SPEED LEVEL 4 then speed will reduce one level at 120 minutes interval till 1st speed and continuously run at 1st speed.
3. If fan is running at SPEED LEVEL 3 then speed will reduce one level at 180 minutes interval till 1st speed and continuously run at 1st speed.
4. If fan is running at SPEED LEVEL 2 then speed will reduce one level at 360 minutes interval till 1st speed and continuously run at 1st speed.

#### Breeze Mode

Breeze mode mimics natural flow of air. After every 30 seconds speed will get automatically Changed. Flow of air sometimes high sometimes less gives you the natural air feeling.

## Timer

Timer enables user to set turn OFF time up to 8 hours in the interval of 2 hours.

2 h: Press the "Timer" Button to set Timer for 2 hour & Selected LED Will illuminate for 5 seconds i.e. Fan will work on the set speed for 2 hour before powering OFF automatically.

4 h: Press the "Timer" Button again to set Timer for 4 hour.

6 h: Press the "Timer" Button again to set Timer for 6 hour.

8 h: Press the "Timer" Button again to set Timer for 8 hour

## Reverse

- When reverse button is pressed, Fan will stop and then start running in reverse direction.
- In reverse Fan will rotate by default <100 RPM approx.
- Timer is applicable when fan is running in reverse.
- Modes and speed control will be Deactivated, on pressing Mode/Any speed button buzzer will give 2 Beeps for indication that Fan is running in reverse direction. User has to Switch OFF the fan from Remote and Switch ON from remote for forward direction.

**IMPORTANT** "When Fan is running in reverse, Power goes OFF and comes, Fan will be OFF".

## Scheduler

Scheduler enables user to set fan turn ON and turn OFF time on real time clock.

## Share device (Share Fans)

User can share fans to his family members, all shared members can control fans which are shared to them.

Memory Backup

In case power trips OFF & ON. No need to get up and set the speed again. Last Fan status will be saved in Fan.

**Note:** Scheduler, Share Device (Share Fan) and) will be only available on mobile APP.

## Remote Operating Function:

### 1. Fan Speed ON/OFF:

- Press  button to switch ON and switch OFF fan speed.

### 2. 1, 2, 3, 4 & 5: Press the desired button for their respective fan speed.

### 3. Mode : Breeze / Mop / Sleep Boost

- Press  button to select/deselect respective Mode, selected LED icon will illuminate for 5 seconds

- Breeze  Mode: Fan speed varies from set speed after every 30 seconds.

i.e. fan speed increases progressively upto max speed, then decreases progressively upto minimum speed in loop.

- Mop :  Fan run at 5th Speed for 3 minutes.

- Sleep  Mode: Fan reduces speed level at fixed interval

- 1. If fan is running at SPEED LEVEL 5 then speed will reduce one level at 90 minutes interval till 1st speed and continuously run at 1st speed.

- 2. If fan is running at SPEED LEVEL 4 then speed will reduce one level at 120 minutes interval till 1st speed and continuously run at 1st speed.

- 3. If fan is running at SPEED LEVEL 3 then speed will reduce one level at 180 minutes interval till 1st speed and continuously run at 1st speed.

- 4. If fan is running at SPEED LEVEL 2 then speed will reduce one level at 360 minutes interval till 1st speed and continuously run at 1st speed.

- Boost:  Fan will operate on its max speed.

### 4. Reverse: Press button to select/deselect respective mode

- When reverse button is pressed, Fan will stop and then start running in reverse direction.

- In reverse Fan will rotate by default <100 revolutions per minute approx.

- Timer is applicable when fan is running in reverse.

- Modes and speed control will be Deactivated, on pressing Mode/Any speed button buzzer will give 2 Beeps for indication that Fan is running in reverse direction. User has to Switch OFF the fan from Remote and Switch ON from remote for forward direction.

**IMPORTANT** "When Fan is running in reverse, Power goes OFF and comes, Fan will be OFF".

### 5. 2 h, 4 h, 6 h, 8 h : Press button to select/deselect respective Timer LED icon, selected icon will illuminate for 5 seconds. i.e. Fan will work on the set speed for selected hours before Powering OFF automatically.

### 6. Reset: To enable/disable the Wi-Fi

- Press  button for 5 seconds to enable/disable the Wi-Fi broadcasting in PCB.

## NOTE:

1. Use AAA Battery (2 N) available in box. In case battery is drained, use AAA Battery (2 N) of preferred brand.
2. PCB failure in the circuit due to external regulator will not be covered under warranty.
3. Wall Mount Regulator should be disconnected for fan safety and better performance.
4. Minor reverse rotation/lag when the fan starts, is a normal phenomenon in BLDC Fans, it's not a defect.
5. To deactivate Fan modes (Breeze, Mop, Sleep & Boost) press any speed control button or any other mode button on Remote.
6. After Power cutoff and resume & pressing any speed button, all the Modes and Timer will be deactivated.



## Problem

## Solution

A. Fan does not start

1. Check circuit fuses or breakers.
2. Check line wire connections of the fan.

**Caution:** Make sure Main power is OFF.

B. Fan sounds Noisy

1. Make sure all motor housing screw are snug.
2. Make sure the screws that attach the fan blade to the motor hub is tight.
3. Make sure there is a gap between Top Canopy and Ceiling.

C. Fan Wobbles

1. Don't connect the fan with wall mounted External Regulator.
2. Ensure all blades are of same numerical code.

D. Remote Sensing is poor

1. Change old battery with new.
2. Please ensure the remote is directed towards the fan.

## Warning:

1. Do not damage the blade while installing or cleaning the fan.
2. Do not insert foreign objects between rotating fan blades.
3. Tighten the safety screw & down rod bolt properly and lock with lock nut & split pin.

Tighten the ceiling plate separately with screw in ceiling

## Wiring Diagram:

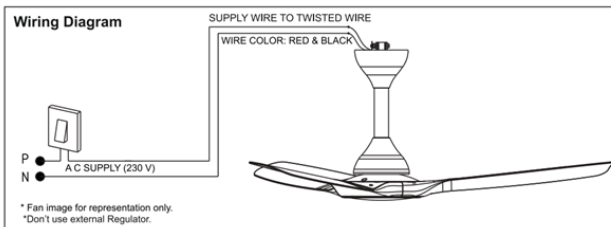

Figure 10

**Note:** Do not to use external "Regulator".

## APP USER MANUAL

### APP INSTALLATION FOR Android™ and iOS

Before setting up app, ensure the following points:

1. Internet connection is necessary to register on the App. A stationary Wi-Fi network (router) is also required for connecting/pairing devices.
2. Fan should be installed according to the instructions and safety guidelines mentioned in the Manual.
3. Havells Sync App will only work for the following mobile OS versions;

Android™	Apple iOS
Lollipop & above	iOS 9 and above

Downloading the app on an Android Smart Phone on Google Play  
 Go to Play Store (Or Scan QR code and follow link)  
 Download and install Havells SYNC app (Figure 11-14)

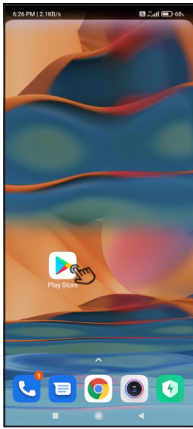

Figure 11

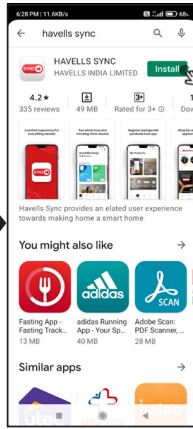

Figure 12

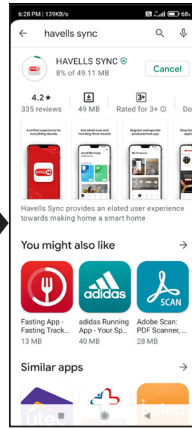

Figure 13

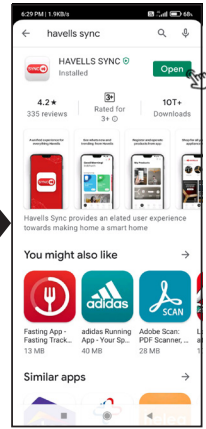

Figure 14

Download the APP for iOS Smart Phone from Apple "App Store".  
 Go to App Store (Or Scan QR code and follow link)  
 Download and install Havells SYNC app ( Figure 15-18)

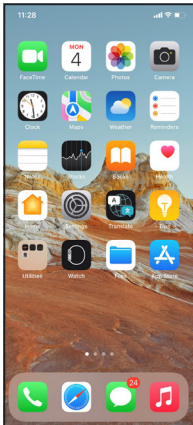

Figure 15

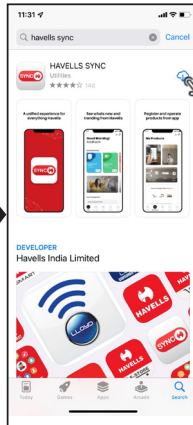

Figure 16

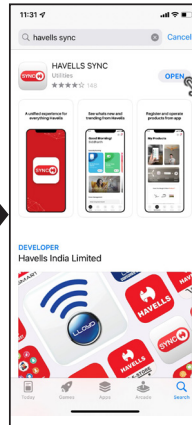

Figure 17



Figure 18



## Setup and Installation of “Havells Sync” Application

Before using Havells Sync, please complete the following configuration in order to exchange the credential between Elio Prime Smart Fan and smart phone.

1. Connect your smart phone with the Wi-Fi Network by selecting the Wi-Fi Network with which the Elio Prime Smart Fan has to be connected.
2. Wi-Fi Network must be at 2.4 GHz band and secured with a Password. Read the router user manual or contact your ISP (Internet Service Provider) for router setting.
3. If firewall is enabled in the network (like in office network), the IP and the device must be allowed .
4. Follow the below steps to configure Elio Prime Smart Fan.

## User Registration

1. Open the APP by taping the “Havells SYNC” icon in your smart phone (Figure 19).
2. On the App, user has to choose Registration type before starting to use the App.
3. The user can be of two types: (figure 21)

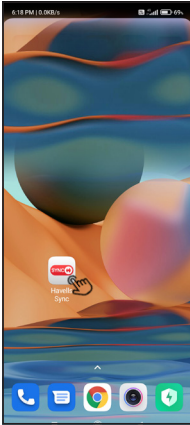

Figure 19



Figure 20



Figure 21

## “New User” Registration

1. Tap on the “NEW USER” and by continuing with the terms & conditions, process further
2. Enter the desired details on the screen displayed (ex. “User name”) (Figure 23)
3. Enter your Email ID in the provided space below (Figure 24)
4. Select whether the product is your own purchased or want to share the device with other user. (Figure 25)
5. In case of new product purchase, choose first option and then you arrive on home screen. (figure 38)



Figure 22

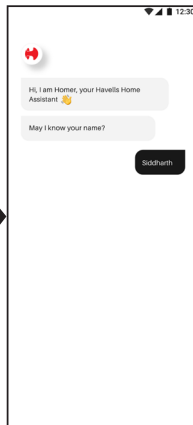

Figure 23

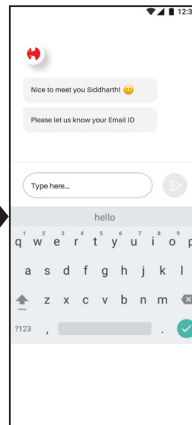

Figure 24

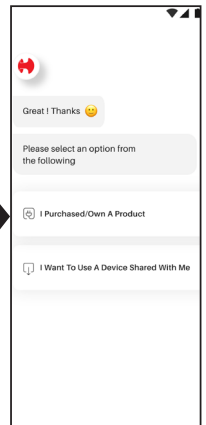

Figure 25

## Add New Device or Use Shared Device

1. Tap on "I want to use a device shared with me" or Add New Device (Figure 25)
2. Click on "OK Proceed" (Figure 26)
3. Enter your mobile number and click on "Next" (Figure 27)
4. Create PIN and click on "Next". (Figure 28)
5. Again confirm the pin entered by you before. (Figure 29)
6. Enter the OTP received, tap on verify OTP (Figure 30)
7. User registration has been successful



Figure 26

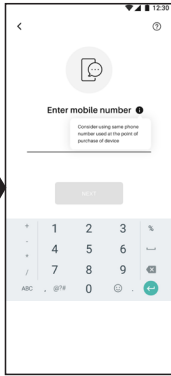

Figure 27

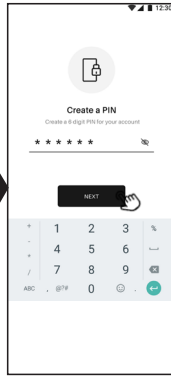

Figure 28

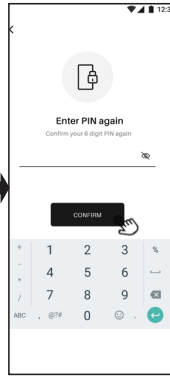

Figure 29

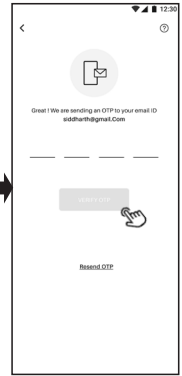

Figure 30

## Existing User Sign-In

1. Tap on "EXISTING USER" and tick by continuing with the terms & conditions. (Figure 31)
2. Enter your registered 10 digit Phone Number and six digit pin to login. (Figure 32)
3. Tap to SIGN IN to enter into your existing registered account.



Figure 31

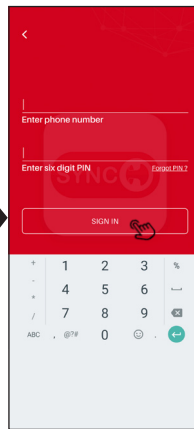

Figure 32

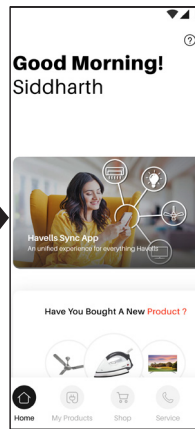

Figure 33

## How to Retrieve/Change forgot pin

1. Enter your registered Phone Number and tap to "Forgot PIN". (Figure 34)
2. Enter your desired New PIN to set and tap on "NEXT" (Figure 35)
3. Re-enter your six digit PIN and tap on "CONFIRM" (Figure 36)
4. Enter your 6 digit OTP sent to your mobile number (Figure 37), if not received click on resend OTP



Figure 34

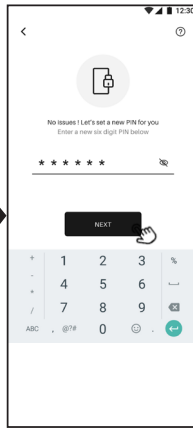

Figure 35

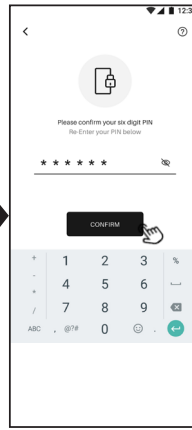

Figure 36

Message pop up  
Havells Sync  
welcomes you.  
Your verification  
code is XXXXXX

Figure 37

### How to Add Device and Set-Up

1. After Login on the Home Screen of Sync App ,Slightly scroll down and tap on "ADD MY SMART DEVICE" (Figure 38)
2. Tap on "SETUP MY SMART DEVICE". (Figure 39)
3. Select Device type as FAN and Model name as Elio Prime Smart Fan and tap NEXT ( Figure 40)

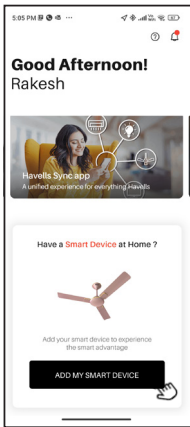

Figure 38

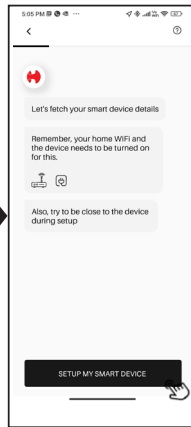

Figure 39

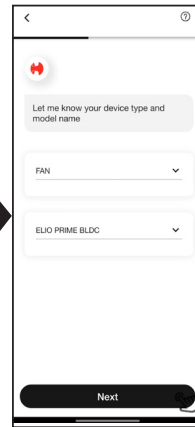

Figure 40

4. App will automatically check for device to connect with Wi-Fi Network and GPS/location ON. Tap on "SETUP MY SMART DEVICE" (Figure 42)
5. Enter the Wi-Fi network password and tap on "Save & Continue" button to proceed further. (Figure 42a)
6. Turn on the Fan using remote handset. In Remote Handset press "Wi-Fi" button, hold for 5 s, 5 beeps sound comes from the Fan PCBA.

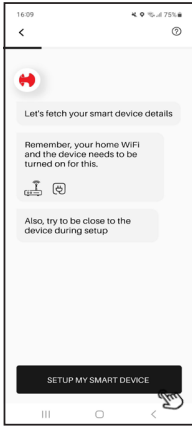

Figure 41

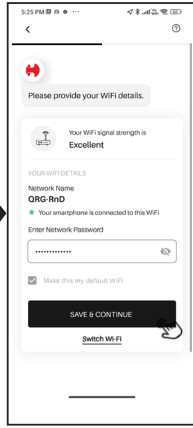

Figure 42

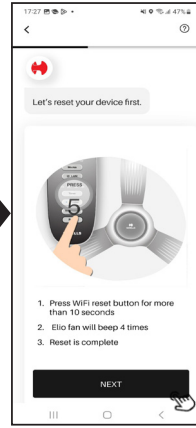

Figure 43

8. Wait till the signal finds the active nearby devices on an APP screen (Figure 44)

9. After successful completion, Tap on "ELIO Prime Fan" to continue (Figure 45) wait till completion of circular bar (Figure 46)

10. Give name to Fan (only alphabets are allowed). Tap on SAVE (Figure 47)

11. Now tap on "START USING MY DEVICE" (Figure 48)

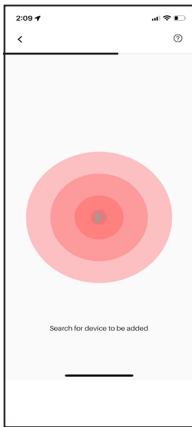

Figure 44

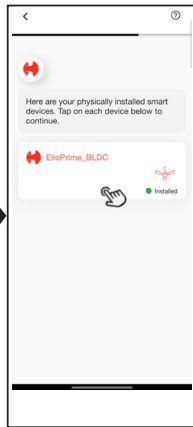

Figure 45

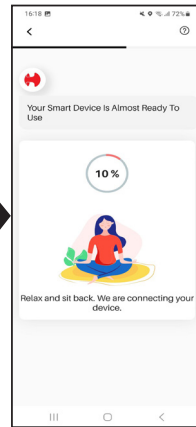

Figure 46

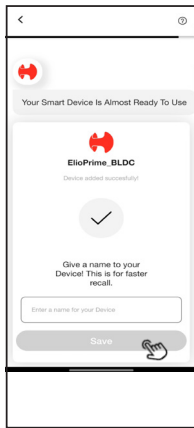

Figure 47

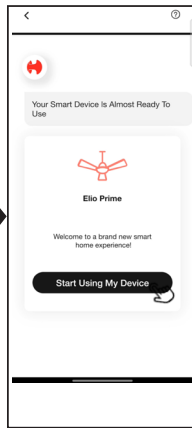

Figure 48

### In case of Unsuccessful Registration:

1. If device registration is unsuccessful, below message will be displayed on an App. (Figure 49) Please recheck the reasons listed on mobile screen, carefully check and rectify if any problem exists.
2. Press the "SEARCH DEVICE AGAIN" button to search the network again,
3. If Device addition is still unsuccessful Press "RESET DEVICE" button & hold it up to 10 secs to reset the device (Figure 50) and follow instructions App. it will continue as in previous section (point no. 8 onwards). (Figure 51)
4. Even after above procedure if device addition is unsuccessful than contact Customer care (Figure 53).

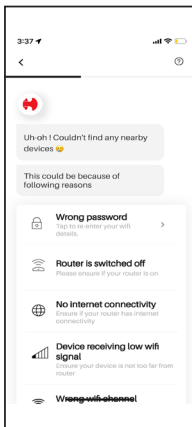

Figure 49

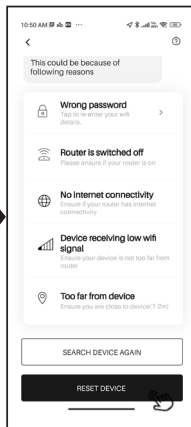

Figure 50

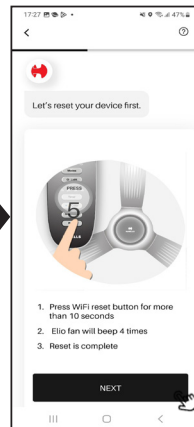

Figure 51

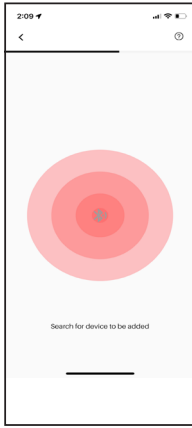

Figure 52

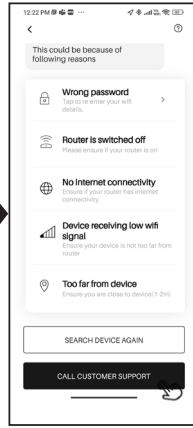

Figure 53

### Havells Sync Device Menu details

DEFAULT HOME PAGE

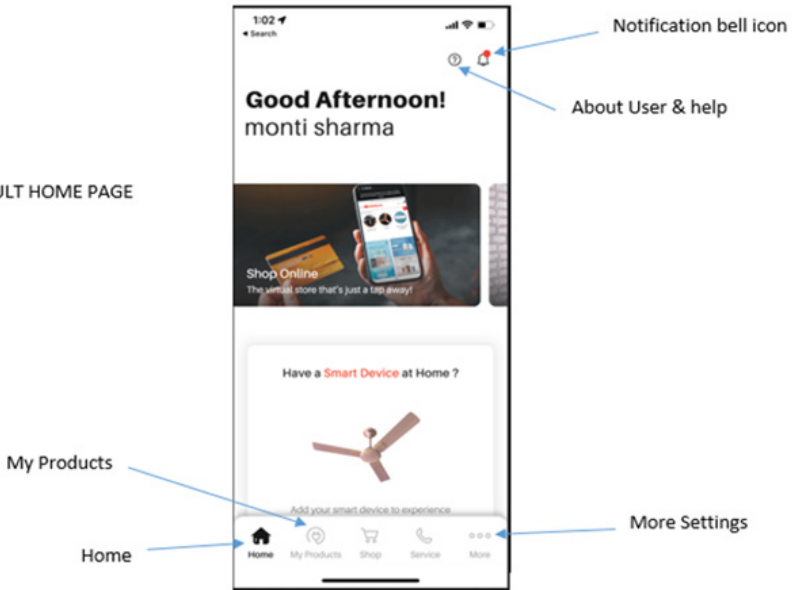

Figure 54

## Overview of “Havells Sync” Application and Dashboard – Fan

At home page, tap on “My Products” (Figure 54) and tap on “Operate Smart Products”, then select ELIO Prime Fan (Added Fan/Device).

Fan/Device Control page will appear as below (Figure 55).

### All Function Display

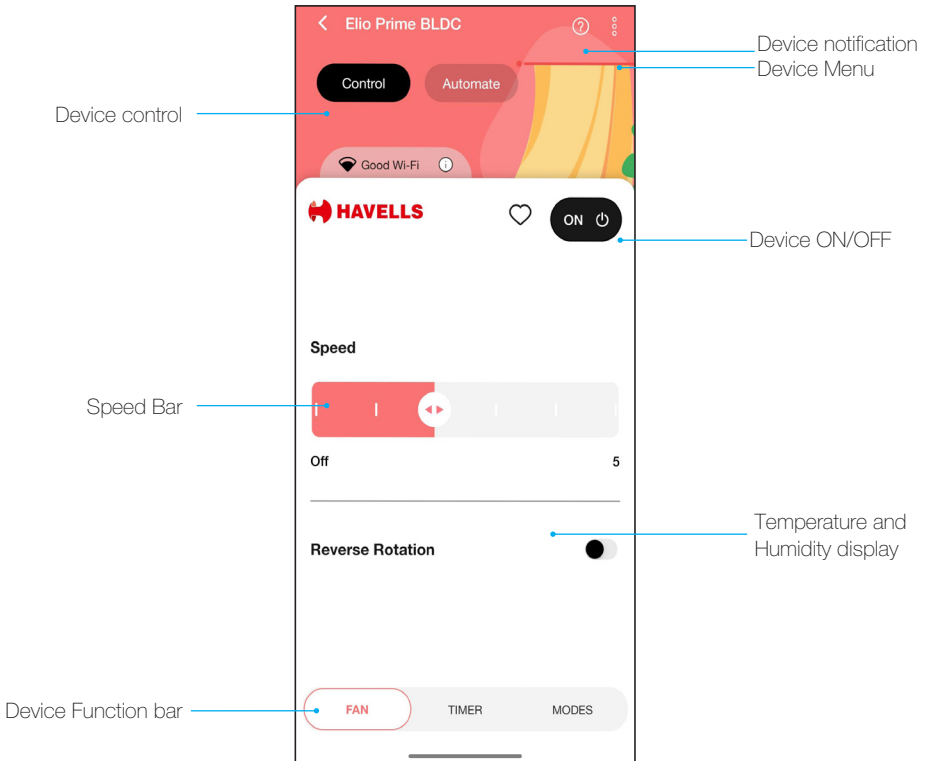

Figure 55

### Delete Saved Device

1. Tap to Device menu on above right corner (Figure 55)
2. Press on “delete the device” to remove the device in an APP (Figure 56)
3. Now the device has been successfully deleted and can no longer be found in your saved devices.

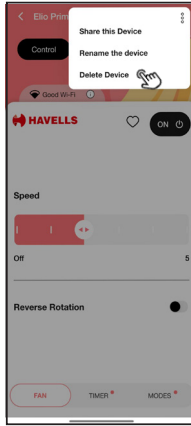

Figure 56

### Operation of “Havells Sync” Application

1. Speed can be selected (1-5) by tapping or sliding on speed bar at desired speed. (Figure 55)
2. To set the Fan reverse rotation, Tap on the Icon appear on the screen (Figure 57)
3. To set Timer, tap on Timer icon, Timer menu will appear, Select timer value (1-8) by tapping (dragging/sliding) on timer bar. (Figure 58)

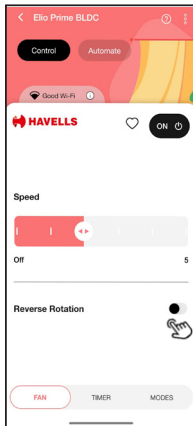

Figure 57

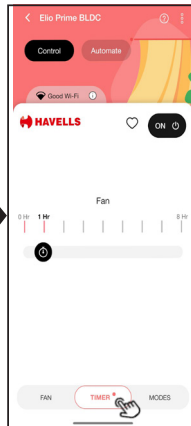

Figure 58

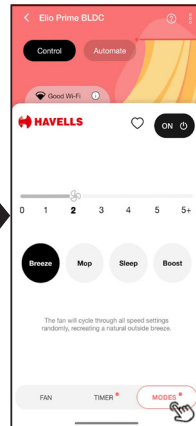

Figure 59



4. Fan Modes can be set by tapping MODES icon Page, Mode Menu Screen/Window will appear. (Figure 59)
5. Fan Modes (Breeze, Mop, Sleep OR Night & Boost) can be selected by tapping / selecting particular mode icon on screen.

### How to Share Device/Fan

1. The user with whom, you want to share device, must be registered to “Havells Sync “App.
2. At device control page, select menu – Tap “Share this device” – Then “Invite new members” – select member from contact list – Select devices/Fans to share and click “DONE” (Figure 60-62)
3. Invite to use device will be sent to invitee, they check bell icon in their Havells SYNC App account.

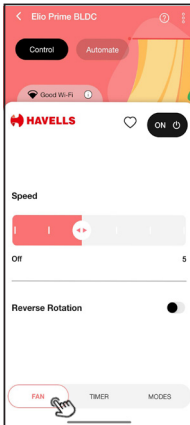

Figure 60

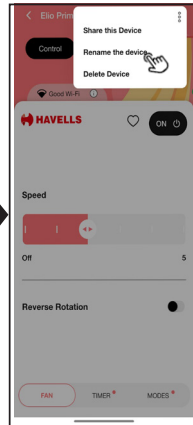

Figure 61

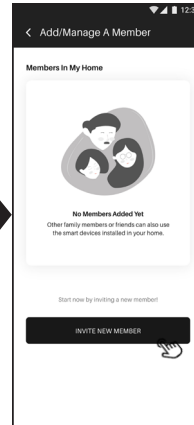

Figure 62

### Automation /scheduling

1. Go to device control page, click “Automate” – Tap on “Create new automation” fill the required details then click Create. (Figure 63-66)
2. Automation will be done as per your requirements. (Figure 67)

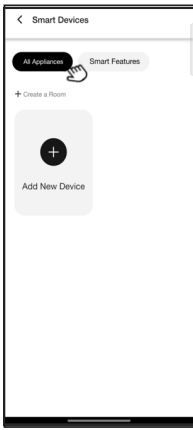

Figure 63

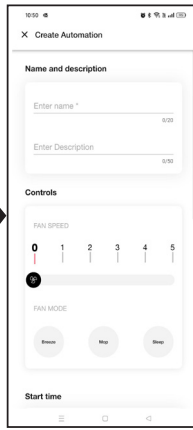

Figure 64

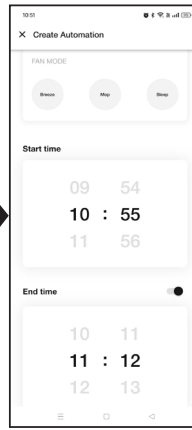

Figure 65

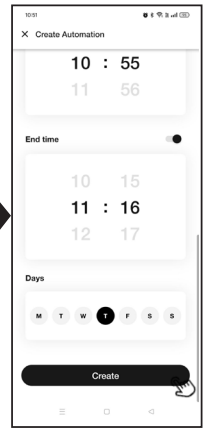

Figure 66

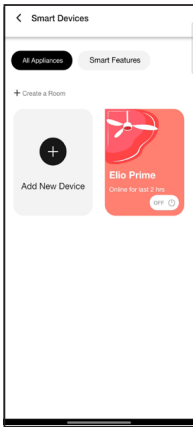

Figure 67

## ALEXA SKILL ENABLING AND FAN OPERATION

### Pre-requisite.

1. Stable Wi-Fi Network.
2. Alexa Device should be ready, signed in with amazon account.
3. Alexa smart phone App signed in with same Amazon Account.
4. ELIO Prime Fan connected to a stable Wi-Fi Network.
5. "Havells Sync" signed in and connected to ELIO Prime Fan.
6. "Havells Sync" account details. Note: Refer Section, APP User manual (Page 8 to 16) for setup using 'Havells Sync' APP Account".

### Set up Alexa enabled ELIO Prime Fan

1. Download/Install Alexa from Play store. (Figure 68, 69)
2. Login to Amazon Account, Alexa Home screen will Appear (Figure 70)
3. Run the App with voice recognition.

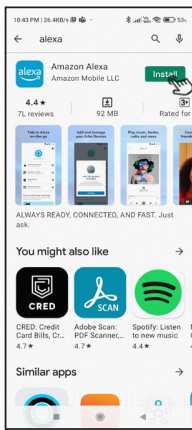

Figure 68

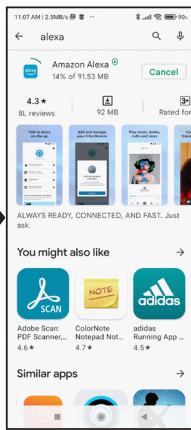

Figure 69

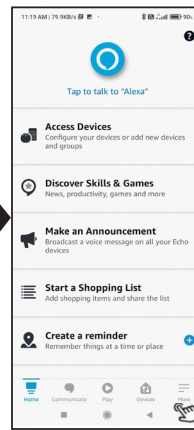

Figure 70

### Link "Havells Sync" Skill to Alexa

1. Tap on "More" from the bottom menu options. (Figure 70).
2. Go to "Skills & Games" (Figure 71).
3. Search Havells Sync and select it (Figure 72).
4. Tap on "ENABLE TO USE" (Figure 73).
5. Enter Havells Sync account details to authorize Amazon Alexa to Link
6. Select "Sign In" (Figure 74).

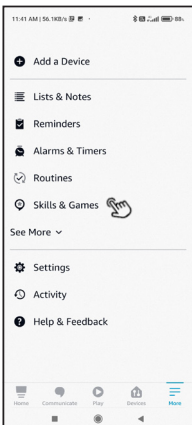

Figure 71

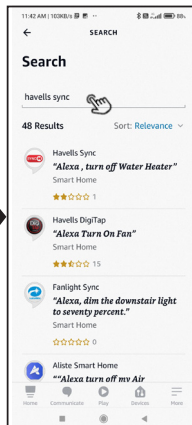

Figure 72

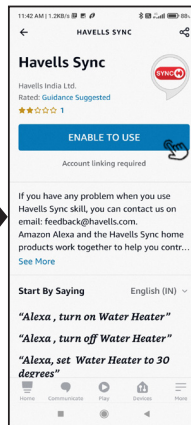

Figure 73

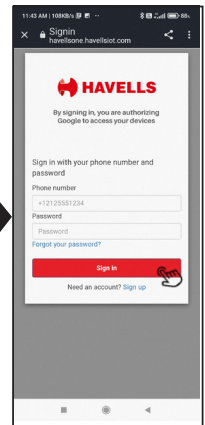

Figure 74

## Add a Device to Alexa

1. Havells Sync will be linked with Alexa, Now Discover devices (Figure 75, 76).
2. Tap on devices, Elio Prime Fan added to device list, Tap ON, the device operating menu will appear. (Figure 77-78)

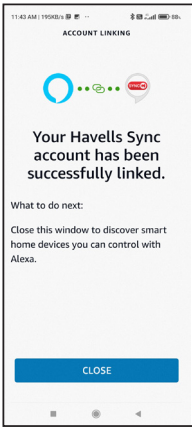

Figure 75

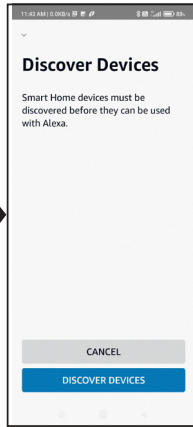

Figure 76

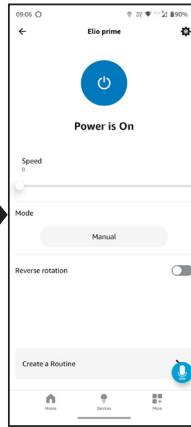

Figure 77

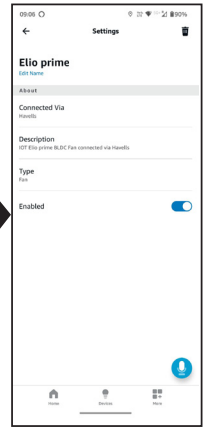

Figure 78

## Confirmation Ready to operate

1. After successful completion of pairing of Sync, Alexa APP will automatically show the connected device in your home page.
2. Alexa will automatically discover all devices associated with Havells Sync Account.
3. After successful linking of Havells sync account with Alexa, the linked device will show at device home page (Figure 77)
4. Tap on device ELIO Prime Fan, the above Fan Homepage screen will appear (Figure 78)

## Control your ELIO Fan using voice recognition feature

Following are some examples of basic voice commands available to control various Functions:

### Fan Main Power

Alexa, "turn on <Device name>"

Alexa, "turn off <Device name>"

### Fan Speed Control

Alexa, "what is the <device name> Speed / Fan Speed / Air Speed?"

Alexa, "set <Device name> fan speed to low"  
Alexa, "set <Device name>fan speed to medium"  
Alexa, "set <Device name>fan speed to high"  
Alexa, "set <Device name> to speed one"  
Alexa, "set <Device name> to speed two"  
Alexa, "set <Device name> to speed three"  
Alexa, "set <Device name> to speed four"  
Alexa, "set <Device name> to speed five"  
Alexa, "decrease <Device name> speed by 2"  
Alexa, "increase <Device name> speed by 2"

### **Fan Mode Control**

Alexa, "set <Device name> to manual | manual mode"  
Alexa, "set <Device name> to breeze | breeze mode"  
Alexa, "set <Device name> to mop| mop mode"  
Alexa, "set <Device name> to sleep| sleep mode"  
Alexa, "set <Device name> to boost| boost mode"

### **Reverse Rotation**

Alexa, "turn on the <Device name> Reverse Rotation"  
Alexa, "turn off the <Device name> Reverse Rotation"

## **Google Assistant Configuration and Fan Operation**

### **Pre-requisite**

1. Stable Wi-Fi Network.
2. Google Assistant-enabled device ready and signed in with Google Account.
3. Google Home smart phone App signed in with same Google Account.
4. Havells ELIO Prime Fan connected with stable Wi-Fi Network.
5. Latest version of Havells Sync APP on Google Play store.
6. 'Havells Sync' signed in and connected to Havells Elio Prime Fan.
7. 'Havells Sync' APP account details.

### **Note:**

1. Refer to Google Device user manual for setup procedure.
2. Refer Section, APP User manual (page 8 to 16) for setup using 'Havells Sync' APP Account".
3. Select Language as India English in Assistant setting.

### **Connect your Havells device in the Google Home app**

1. Tap on your profile photo at the top right corner of the screen. (Figure 79)
2. Select "Assistant Setting" from the options. (Figure 80)
3. Search "Home Control" from the available setting options. (Figure 81)
4. Search "Havells Sync" action in the search bar. (Figure 82)
5. Tap on "Havells Sync" to continue. (Figure 83-85)

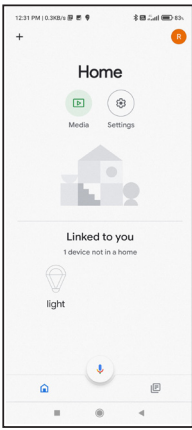

Figure 79

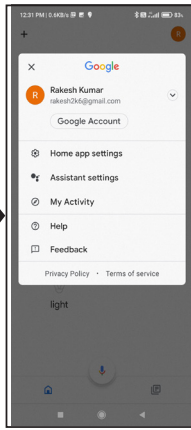

Figure 80

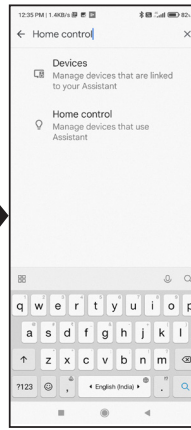

Figure 81

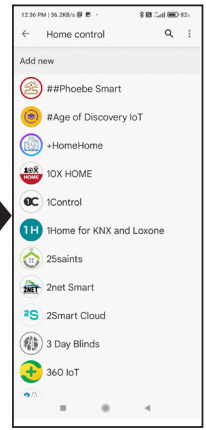

Figure 82

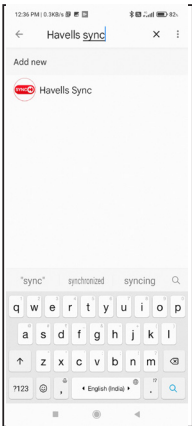

Figure 83

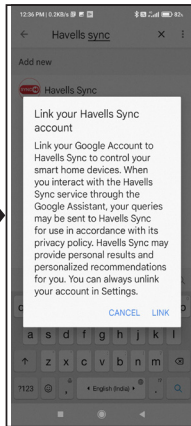

Figure 84

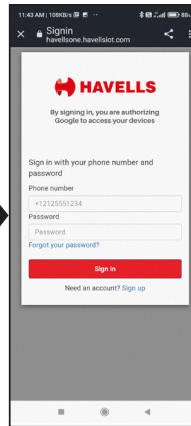

Figure 85

### Link “Havells Sync” skill in Google Assistant

1. Enter Havells Sync APP account details to link Google Assistant with your Havells device. (Figure 85)
2. Tap on “Sign In” button to confirm. (Figure 86)
3. A confirmation message will be displayed. (Figure 87) Click on “Done” to finish pairing the device

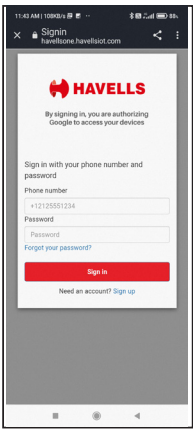

Figure 86

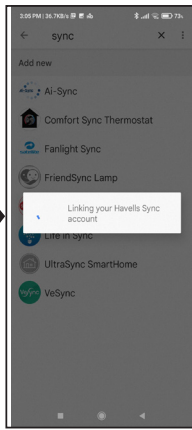

Figure 87

### Device discover in Google Home App

1. After successful completion of pairing of Havells Sync, Google Home App will automatically show the connected device in your home page. (Figure 88)
2. Google Home app will automatically discover all devices associated with Havells Sync Account.

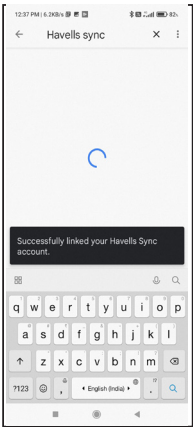

Figure 88

### ELIO Prime Fan Control using Google Home App

1. On the home page, connected devices are shown. "Click" on the connected device. (e.g. "ELIO Prime Fan"), linked ELIO Prime Fan will be displayed with the current status (OFF/ON/other) (Figure 89)
2. Tap on "OFF" to turn ON ELIO Prime Fan. (Figure 90)
3. Tap on "ON" to turn OFF ELIO Prime Fan. (Figure 90)
4. You can change name of device or unlink the account by clicking on the "setting" icon on top right corner. (Figure 91)

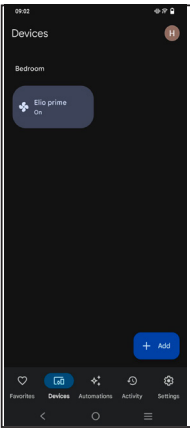

Figure 89

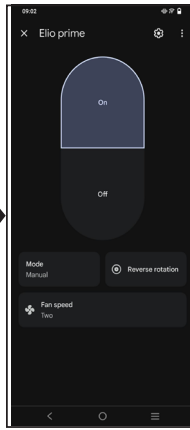

Figure 90

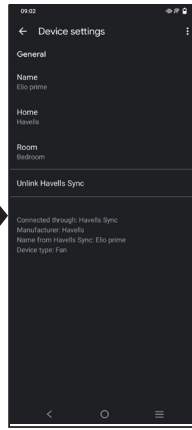

Figure 91

## Control your ELIO Prime fan using just your voice with Google.

Try saying "Hey Google" followed by one of the commands listed below:

### Fan Main Power Control

Hey Google, Is <Device name> turned on?

Hey Google, "Turn on <Device name>."

Hey Google, "Turn off <Device name>."

### Fan Speed Control

Hey Google, "What is the <Device name> speed?"

Hey Google, "Set <Device name> on speed one"

Hey Google, "Set <Device name> on speed two"

Hey Google, "Set <Device name> on speed three"

Hey Google, "Set <Device name> on speed four"

Hey Google, "Set <Device name> on speed five"

Hey Google, "Set <Device name> on low"

Hey Google, "Set <Device name> on medium"

Hey Google, "Set <Device name> on high"

### Reverse Rotation

Hey Google, "Turn on reverse rotation for <Device name>"

Hey Google, "Turn off reverse rotation for <Device name>"

### Fan Modes

Hey Google, "Is the <Device name> set to manual | manual mode?"

Hey Google, "Set <Device name> on breeze | breeze mode"

Hey Google, "Set <Device name> on mop | mop mode"

Hey Google, "Set <Device name> on sleep | sleep mode"

Hey Google, "Set <Device name> on boost| boost mode"

Hey Google, "Set <Device name> on manual | manual mode"



## TROUBLESHOOTING APP INSTALLATION AND OPERATION

Sl. No.	Trouble	Possible cause	Resolution
1.	During registration OTP not received	There may be server busy or entered wrong mobile number.	Wait for 3 minutes - 5 minutes. Even if OTP not received, check for mobile no. entered during registration process. 1. Start register process again with correct mobile no.
2.	After Press of "Wi-Fi RESET" button 5 beep sound not appeared	1. Fan is not power On 2. Remote battery bad/ not installed correctly.	2. Check for Fan power ON 3. Press continuously for 5 s
3.	"Wi-Fi RESET" button pressed by mistake on remote		Required to re-register fan to your APP account.
4	Fan configuration /Addition to APP unsuccessful	1. Wi-Fi Details incorrect 2. Internet connectivity 3. Firewall and other restrictions	4. Check Wi-Fi SSID and Password is correct 5. Fan in Configuration mode and Wi-Fi Symbol is blinking on the display unit 6. Check any firewall or any other restriction in Wireless router. 7. Check the router is working properly. 8. Make sure that Fan is in the range of Wireless router. 9. Check the internet connectivity in wireless router
5	After Power ON the Fan, it is showing Offline On APP	1. Network problem 2. APP connection timing.	1. Check for Network stability 2. It takes 2 minutes - 5 minutes to show online depending on network speed and server response.
6	If Alexa or google does not recognize the fan	Possibly in Alexa or google "Havells SYNC" skill is not enabled.	You need to enable "Havells Sync" Skills in Alexa or Google home Follow the procedure in manual.
7	Fan speed level changing its own	Possibly fan operating mode set to sleep mode.	Select normal mode through RF remote or mobile App.
8	Fan speed changing randomly its own	Possibly fan operating mode set to Breeze mode.	Select normal mode through remote or mobile App.
9	Applied Sleep Mode but not activating.	Sleep Mode works Speed 2 onwards.	Set Speed 2 or above. (Decrement of speed is as per description in Fan Feature section)
10	Wanted to deleted Automation but it is not deleting	When Automation is in running condition it can't be deleted	1. Wait for Automation to complete than try to delete. 2. Need to delete the device from APP than re add/configure
11	Edited Automation to some other timing but speed selected with Sleep mode is not correctly deployed	While editing the Automation you need to re select Speed and Mode also	1. Move and re select the speed selection bar 2. Remove and Mode and reselect and try again.

### Note:

1. Picture and procedure used to describe Sync APP, Alexa and Google operations, may slightly differ with phone models/OS and APP versions.
2. All the App and Voice enabled (Alexa and Google) features are based on Internet speed and Cloud response, in case any one or both deteriorate, these features temporarily no work properly.
3. Google and Google Home are trademarks of Google LLC.
4. Amazon, Alexa and all related logos are trademarks of Amazon.com, Inc. or its affiliates.

# E-WASTE DISPOSAL

## Environmental Compliances:

As per the rules laid down by the Government for environmental concern & safety, your product has been made to comply and conform to the respective regulation as listed below. This product falls under the E-WASTE (MANAGEMENT) RULES, 2022 with all amendments of Ministry of Environment, Forest & Climate Change.

## RoHS Declaration:

This Product is in conformity with requirements of Rule 16 of the E-WASTE (MANAGEMENT) RULES, 2022 with all amendments. The content of hazardous substances with the exemption of the applications listed in SCHEDULE II of the E-Waste (Management) Rules, 2022 with all amendments is as follows:

- Lead (Pb): not over 0.1% by weight;
- Mercury (Hg): not over 0.1% by weight;
- Cadmium (Cd): not over 0.01% by weight;
- Hexavalent Chromium (Cr6+): not over 0.1% by weight;
- Polybrominated Biphenyls (PBBs): not over 0.1% by weight;
- Polybrominated Diphenyl Ethers (PBDEs): not over 0.1% by weight.

## Do's and Don'ts for disposal of product:

### 1. Do's:

- Always drop your used electrical/electronic products, defective spares or any accessories and packaging materials after the end of their life at the nearest authorized collection point/center.
- Make sure that your electronic products are recycled only by authorized recyclers/dismantlers.
- Segregate the packaging materials according to their respective waste disposal options and sorting for recycling.
- Protect the glass surface of any electronic product to avoid breakage.

### 2. Don'ts:

- Never dismantle your electronic product yourself.
- Never sell or give E-Waste to informal and unorganized sectors like local scrap dealer/rag pickers.
- Never dump E-Waste in garbage bins or municipal solid waste stream.
- Do not dispose your product as unsorted municipal waste.

For more information on safe disposal, recycling and collection point, visit our website <https://www.havells.com/en/discover-havells/ewaste-awareness.html> or write a mail to [ewaste@havells.com](mailto:ewaste@havells.com)

170524/V1

---

Actual products may vary in colour, design, description and colour combination etc.

Although every effort has been made to ensure accuracy in the compilation of the technical detail within this Publication.

Specifications & performance data are constantly changing.

Copyright Subsists. Imitation of trade dress, graphics and color scheme of this document is a punishable offence.

Images, Figure and Drawings are for illustrative purpose only.

---

## Havells India Ltd.

Corp Office: QRG Towers, 2D, Sector-126, Expressway,  
Noida-201304 (U. P.) India Ph. +91-120-4771000  
Email : [customercare@havells.com](mailto:customercare@havells.com), Website: [www.havells.com](http://www.havells.com)  
**Customer Care No. 08045 77 1313** (All Connections),  
011-4166 0303 (Landline)

Join us on Facebook at [www.facebook.com/havells](http://www.facebook.com/havells) and share your ways  
to save the planet !

CIN - L31900DL1983PLC016304

