

Operating Instructions



Storage Electric Water Heater
Adonia i 15 L & 25 L

Dear Customer,

We congratulate you on choosing a **HAVELLS** Electric Water Heater, one of the highly prestigious brand in India.

Meticulously designed, using only the highest quality materials and components, your electric water heater is designed to have many years of trouble free operation.

To enable your electric water heater to give you many years of perfect trouble free service, we recommend you to follow the advice contained in this Instruction manual very carefully.

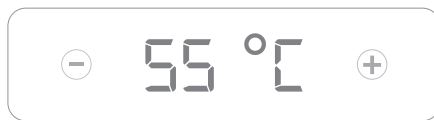
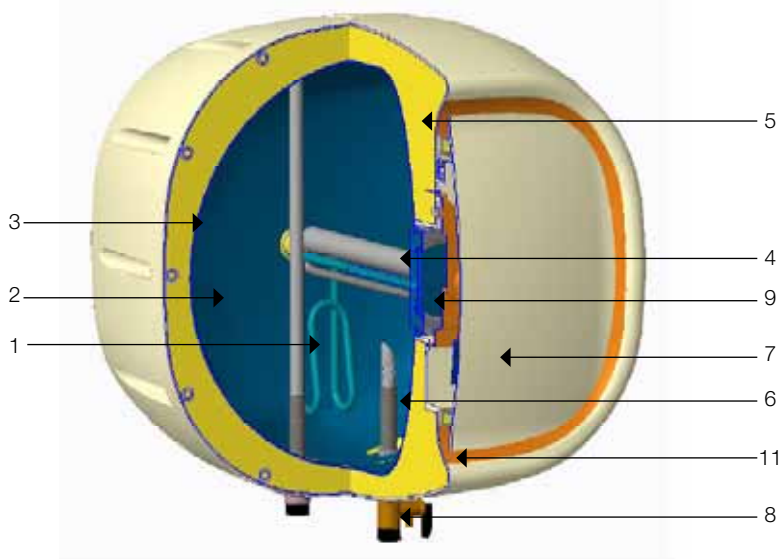

10

1. High quality incoloy 800 glass coated heating element
2. Heavy guage inner tank
3. Ferro glass coating layer
4. Heavy-Duty anode rod
5. Energy saving high density PUF insulation
6. Water tubes with whirlflow
7. Feather touch keys for temperature
8. Multifunctional safety valve
9. 4 N Bolt Flange
10. Digital display for water temperature
11. Color changing LED's for indicating temperature rise of water

General arrangement drawing:

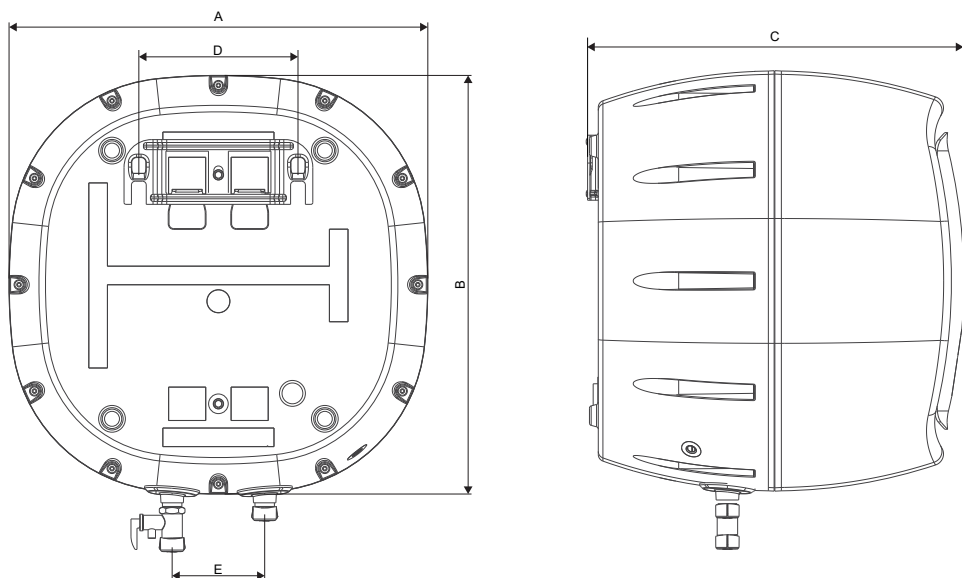

Model	A	B	C	D	E
ADONIA I 15 L	390 mm	390 mm	358 mm	172 mm	100 mm
ADONIA I 25 L	453 mm	453 mm	394 mm	172 mm	100 mm

*Note: All dimensions are in mm, dimensions tolerance ± 5 mm
 Dimensions in mm above refer to mechanical figures in this page.

Technical Specifications:

S.No.	PARAMETER	Adonia I	
1	Rated Capacity in L	15 L	25 L
2	Mounting	Vertical	Vertical
3	Rated Voltage in Volt & frequency in Hz	230 V, 1 Phase, 50 Hz, AC	230 V, 1 Phase, 50 Hz, AC
4	Rated Power Input in W	2000 W	2000 W
5	Rated Input Current in Ampere	8.7 A	8.7 A
6	Max Hot Water Output Temp. (°C)	75 °C	75 °C
7	Rated Pressure in MPa	0.8 MPa	0.8 MPa
8	Standing Loss in kWh / 24 h / 45 °C	0.419 kWh	0.511 kWh
9	Reheating Time in min to raise 50 °C	20 min	35 min
10	Mixing Factor Maximum (%)	30%	30%
11	Weight of water heater in kg		
	- Empty	9.6 kg	12.8 kg
	- Water Filled	25.1 kg	38.1 kg
12	Water Proof Degree	IPX4	IPX4
13	Class of Appliance	Class I	Class I

WARNING:

The installer should review the contents of this manual along with the owner after completion of installation and the manual should be left with the owner and placed at a place close to the installation.

Key Features:



Wi-Fi control with App

Access your water heater through Wi-Fi using IOS/Android App on your smartphone.



Smart scheduler

Scheduler in app which turns water heater on and off automatically at the desired time of your shower.



IOT Enabled Water Heater

1. An IOT enabled Water heater that be remotely controlled from any where in the world using smartphone app.
2. Alerts customer service at the click of a button.
3. Notifies user when water is ready to use.



Works with Alexa and Ok Google



Adonia I display

Feather Touch keys & temp. display

Allows manual setting for heating of water between 25 °C to 75 °C.



Temperature Display:

Color changing LEDs indicates heating of water and related temperature.

Adonia I :- Smooth transition of LED color from **blue** to **amber** and digital display to show the water temperature.



Shock Proof Operation

India's first integrated shock safe plug is designed to prevent injury to humans due to electric shocks, the plug will cut off the power immediately in case of any current leakage.



Ferroglass coated tank with single weld line design:

- A. Tank made of ultra thick superior quality steel.
- B. Provides more corrosion resistance and anti-rust property compared to standard inner tank designs resulting longer life.
- C. Single weld line on the inner tank eliminates the risk of water leakage.



Multifunctional Safety Valve

The MFV used with this unit is a unique safety valve. This has four functions

1. Pressure release valve
2. Non return valve
3. Vacuum release valve
4. Drain device



4 N Bolt flange:

Provides an easier way for product maintenance.



Heavy Duty anode rod protects tank from corrosion:

With steel core, magnesium anode rod protects enameled tank from rust and corrosion.



Incoloy heating element:

Incoloy 800 coated heating element offers superior heating performance With its excellent resistance to both oxidation & carbonization at high temp. setting. Also resists erosion against most extreme and hard water conditions thus extending life span of heating element with minimum energy loss.



Energy saving High density Puf Insulation:

CFC free thicker insulation offers complete protection against radiant heat loss.



Water tubes with whirl flow:

The flow ensures no immediate direct contact between cold and hot water for a faster heating and maximum energy saving effect.



Thermal Cut Out:

Cuts off electric power to guarantee safety, in case the water temperature exceeds the highest temperature beyond pre-set of the thermostat.

Safety Devices:

Havells Water Heater is built-in with a host of Safety Devices to ensure your safety at all times. The operation of these devices are described below:

A. Thermostat / Temperature sensor

This device is provided with a feather touch keys to set the desired water temperature. This device “cut-off” and “cut-in” the power supply between a narrow band of temperature range.

B. Thermal Cutout

A non-self resetting thermal cutout is provided as a safety device. When the thermostat fails to function, this cut-off the power at $93\text{ }^{\circ}\text{C} \pm 5\text{ }^{\circ}\text{C}$ The thermal cutout has to be manually reset before the heater can start operating again.

C. Shock Safe Plug

This water heater is equipped with a shock safe plug which will cut-off the power immediately in case of an electrical leakage. This will ensure protection against electric shock in case of any current leakage. In order to ensure that the shock safe plug is working normally, press the 'Testing' button on the device. If it cuts off the power to the water heater, it means that it is working properly. After testing, please press reset button to restore normal functioning of the water heater. It is advisable to periodically repeat this test to verify the functioning of the shock safe plug.

D. Multi Function Valve (MFV)

1. This valve prevents the built-up of excessive pressure within the water heater by releasing water from the drain.
2. It also acts as a non-return valve to avoid the return of water from the water heater back to supply, thereby prevent the dry heating.
3. It acts as an expansion valve to allow the hot water expansion during heating which flows back through drain.
4. Customer can ensure proper working of the MFV by cleaning of salt deposits, by lifting the drain leve up.

Customer can drain out the water from tank in case of prolonged non-use of water heater.

⚠ CAUTION

Ensure no leakage of water through inlet and outlet joints.

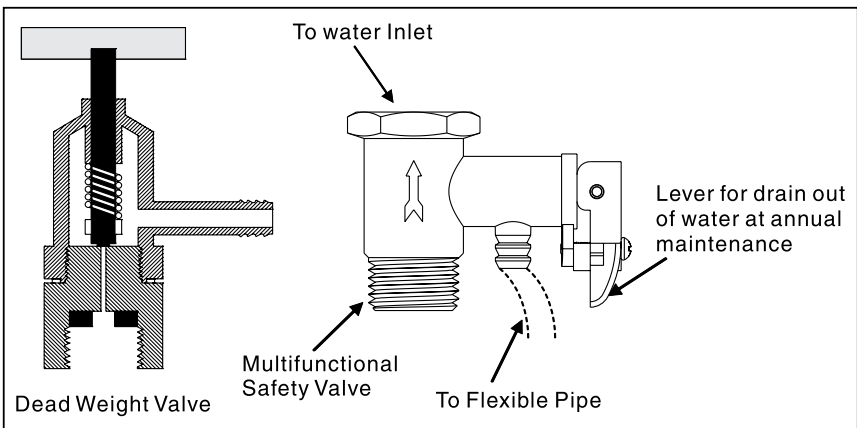

Picture 1

Picture 2

Installation & Safety :

- A. Always use services of qualified plumber/electrician to install this unit.
- B. For easy installation and servicing enough space should be provided around this unit (5 cm from ceiling, 50 cm from sides & minimum 1.8 m from ground).
- C. Ensure following tools and accessories are made available before installation of this unit. (not provided by company)
 - 1. Drilling machine with concrete drill bit, set spanner and tool kit.
 - 2. 2 N of metal flexible pipes.
 - 3. PVC pipe for drain

Preparation of Wall Structure

For installation of this unit, you need to prepare the wall suitably.

A. In case of hollow brick walls.

- 1. Dig up sufficient space to accommodate the wall mounting bracket (bracket supplied with water heater) of minimum depth 10 cm
- 2. Fill up the complete dig up space with cement concrete.
- 3. Ensure cement concrete is properly cured/set.
- 4. Then, the wall bracket can be fixed with the help of bolts provided along with the unit.

B. In case of solid walls

Follow process as below :

- 1. Drill hole in wall as shown Picture B.
- 2. Insert the nut/bolt assembly in drilled hole, take out the bolt (as shown) Picture B.
- 3. Fix the wall plate with the bolt and washer by testing till the wall plate is firmly fixed, in order to carry the weight of water heater safely (with water).

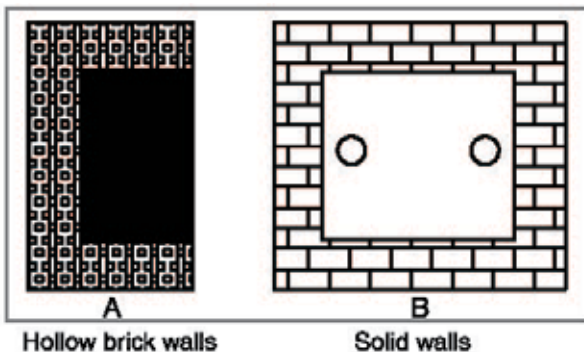

Mounting

Now the water heater can be hooked on the wall bracket.

1. After hooking on bracket, tug downward the water heater and ensure both fingers of bracket are properly seated in the mounting slot.

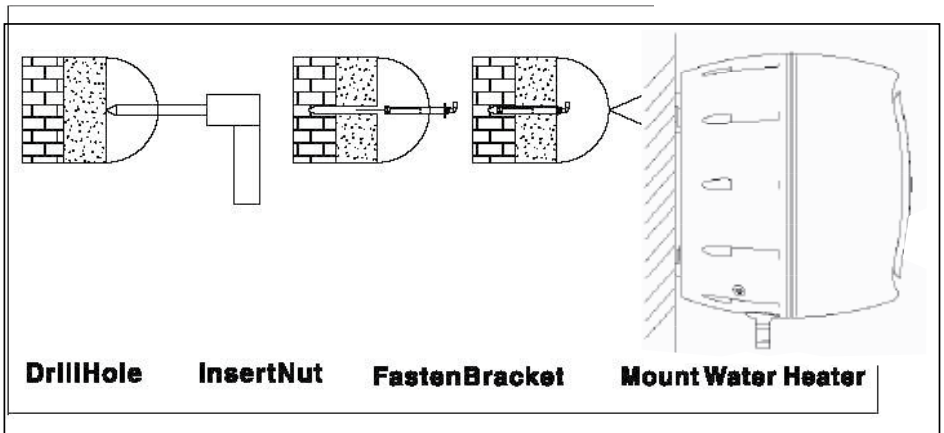

2. Do not install in the area of direct sunlight and water splashes.

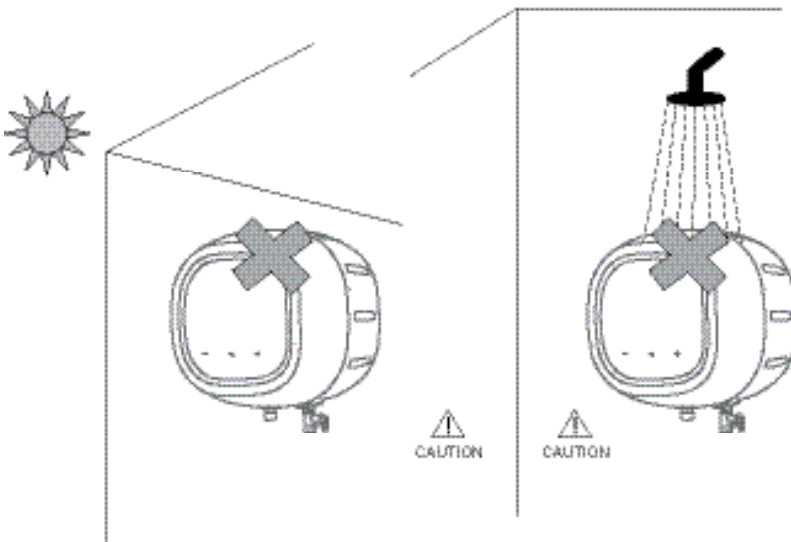

Picture-2

Water Connections



CAUTION

Do not connect the inlet directly to water lifting pump.

Do not SWITCH ON water heater without water filled in tank

1. In case inlet water pressure is more than 0.8 MPa or water pressure head 80 metre, install the dead weight valve before inlet as shown in Picture 2 (not provided with this unit).
2. Minimum height between the water heater and water supply tank should be atleast 1 metre.
3. For connecting the inlet & outlet between water heater and bathroom fittings, use metal flexible pipes having plastic nut / plastic adapter.
4. Cold water inlet is marked blue and hot water outlet is marked with red.
5. First, fix the multifunction valve (MFV) to inlet of water heater
6. Connect cold water inlet to other end of MFV with metal flexible pipes having plastic nut / plastic adapter.
7. Open inlet water tap and allow the water to fill in the water heater. Make sure that the water starts flowing from outlet of water heater.
8. Connect the outlet of water heater with metal flexible pipe having plastic nut / plastic adapter to hot water outlet point of bath fitting. Open the tap & valve to verify that water is flowing through the hot water tap.
9. Connect MFV with PVC pipe for drain see Picture 3.

Electrical Connections

1. This unit is provided with all internal connections / wiring made in the factory itself.
2. The water heater is provided with a supply cord, with an in-built ELCB and a 3 pin plug top of 16 A
3. Make sure that the electrical contact of 3-pin plug and switch is secure with proper earthing.
4. To energize water heater, plug in the 3-pin in socket for electric supply.
5. Type C 16 A double pole MCB or 16 A fuse must be used as a backup protection for overload.
6. To ensure proper functioning, use test button in the shock safe plug at least once a month.
7.  Shock safe plug does not eliminate the risk of electric shock but limits duration of passage of current through human body for such a short time, probabilities of a lethal effect are reduced to a minimum.
8.  IEC: 61540 recommend that shock safe plug should not be considered as a sole means of protection it is essential to provide proper earthing and all parts of the system should be properly insulated.

Internal Wiring Diagram -

The schematic diagram shows the internal wiring. Make sure that the Water Heater is switched off and plugged-off from electrical supply before opening the Inspection cover.

Follow the Internal wiring connections as shown in the diagram below while carrying out the maintenance.

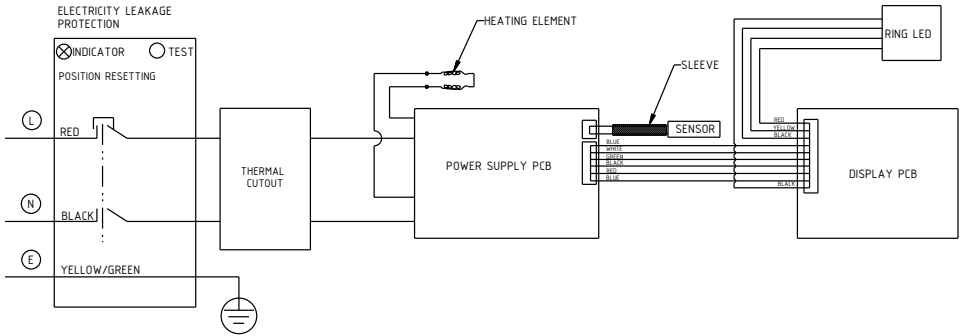

OPERATING INSTRUCTIONS:

- A. USING THE GEYSER WITH THE HAVELLS SYNC APP.**
The Application Can Be Downloaded From Play Store For Android Devices And App Store For Apple Devices.

BEFORE SETTING UP THE APP, ENSURE THE FOLLOWING POINTS:

1. Internet is mandatory for registration.
2. Make sure the geyser is installed according to the instructions and safety guidelines provided as mentioned earlier.
3. Minimum Android and IOS versions required for supporting the app are:
Android – Android 6.0 Marshmallow
iOS – iOS 9

If the device is not connected to the router “dot” near seven segment display will blink once per second and will disappear when connected to the home router.

How to register in app



Open App and click on new user'



Homer, the smart assistant, will now guide through pages where user can fill details like name, email-ID, product purchased etc. Once done, app will land in this page. Click "Ok,Proceed".



Enter mobile number



Create a 6 digit PIN for security and confirm the same.



You will receive an OTP and registration will be done.

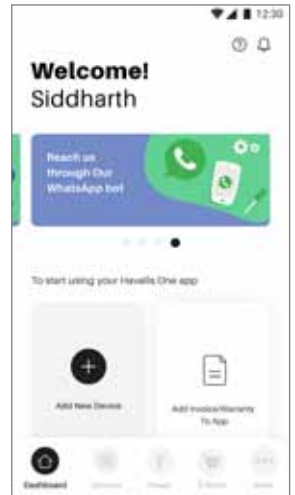

Registration is complete and user will be guided to dashboard page.

How to login in app



Open App and click on "existing user".



Enter registered mobile number and pin and tap on "Sign In".

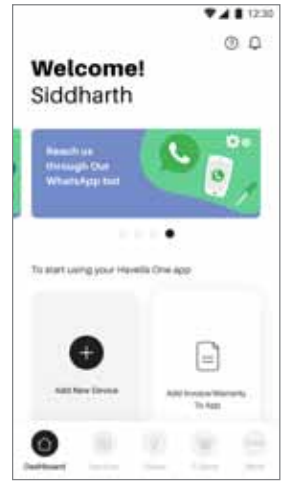

Sign-in is successful and user will land in Dashboard page.

How to add geysers in app



Tap on add new device



Adding a new device process will start

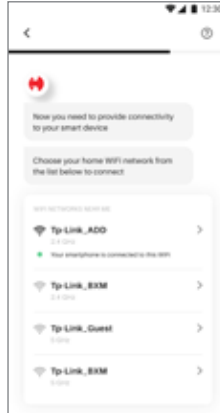

Select your home router SSID network from the list



Provide your home router password

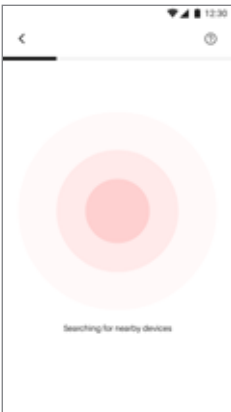

App will search for the nearby installed devices



Device will be detected and shown. Tap to continue setup



Device addition in progress



Device added. Rename to use

How to control geyser from app



Go to devices section. You will see your devices listed. Tap on the desired device.

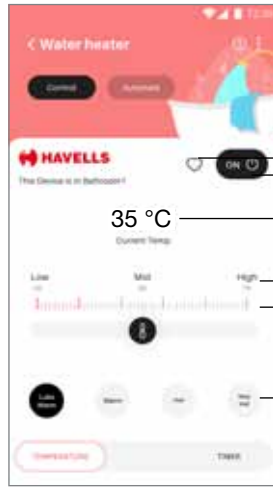

Device details page will open with all the temperature control view.

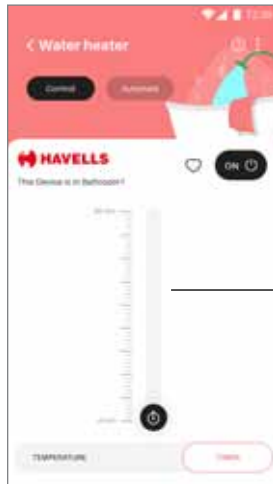

Tap on timer tab below to go to timer control view

How to set automation

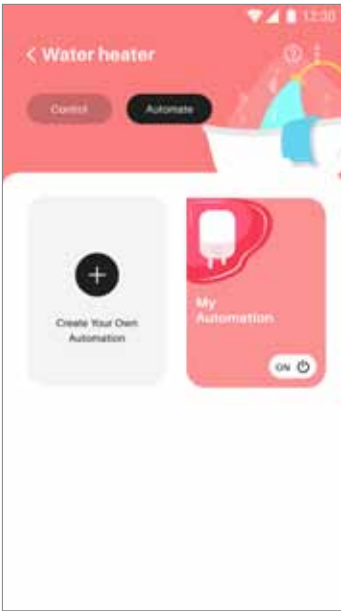

Go to automate tab in device details page. Tap on create a new automation



Create automation page will open.

Automation name and description

Controls

Time when automation should kick off

Time when automation should end.

Days in week when automation is desired



New automation is created and is reflected in automation tab. You can tap to see the details.



Automation details page. You can enable/disable, edit and make this automation a favorite from this page.

How to delete a device



Go to device page and long press on the device you wish to delete

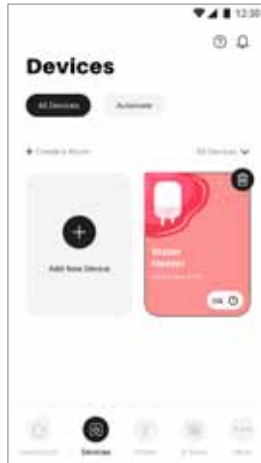

Device now will be selected. Tap on the delete icon.



Tap delete on the confirmation dialogue and device will be deleted.

How to delete an automation

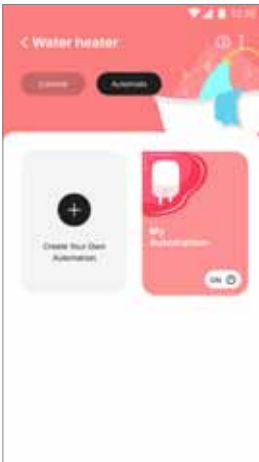

Go to device page and long press on the automation you wish to delete



Automation now will be selected. Tap on the delete icon.

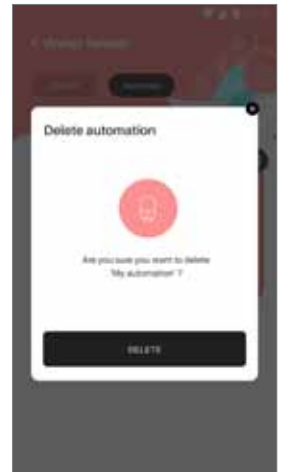

Tap delete on the confirmation dialogue and automation will be deleted.

How to share the geyser device with others

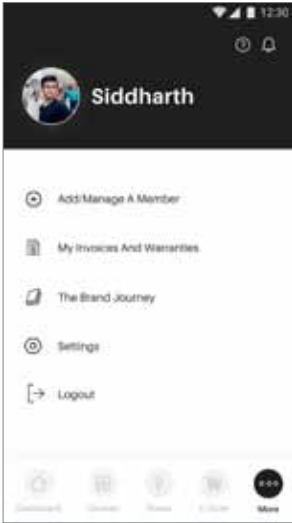

Go to more section and tap on Add/manage a member

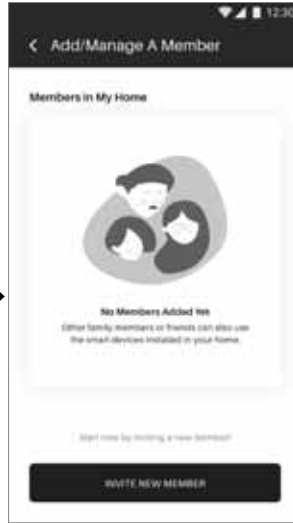

Tap on invite a new member

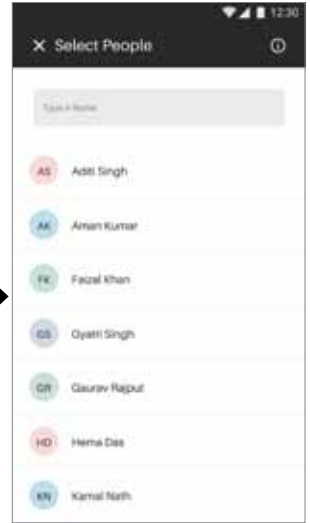

Your phonebook will open. Select the member with which you want to share your device



Select the devices to be shared.

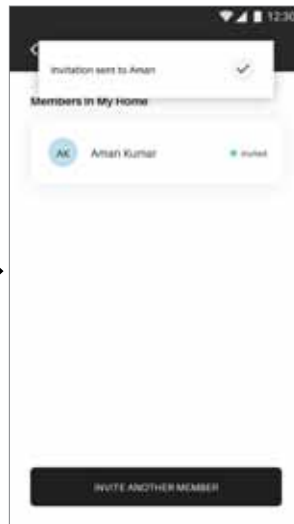

Invitation for sharing will be sent to the user.

If device is shared from User 1 to User 2, then User 2 should click on the notification bell and accept the invitation for a new device, then only it will get added in his list of devices.

How to access help and support

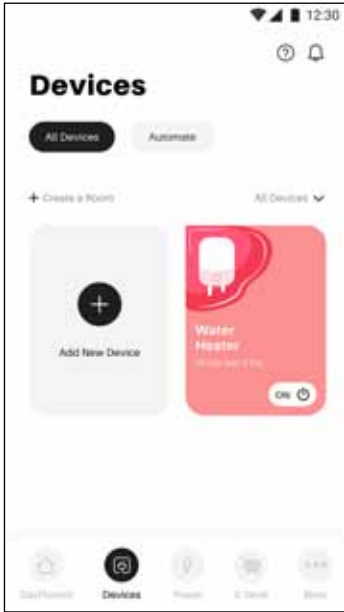

On any page in app, tap on the help icon on top

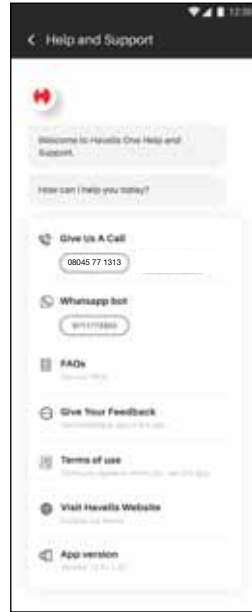

Help and support page will open.

In case the geyser shows the following error codes on the display, the error codes have been described below:-

- E 2: If water temperature reaches 90 °C.
- E 3: NTC is open circuit : When there is no voltage across the sensor.
- E 4: NTC is short circuited. : When there is maximum voltage across the sensor. [nearly 5 V]
- E 5: Dry heating detected. Heating will cutoff when it senses high temperature rise rate without water.

Smart Assistant's Voice Control

1. Alexa Smart assistant

1.1 Alexa & Havells Sync Account linking process

1. Launch Amazon Alexa app on your device.



2. Open More and select Skill & games



3. Select Search on skill & games page.

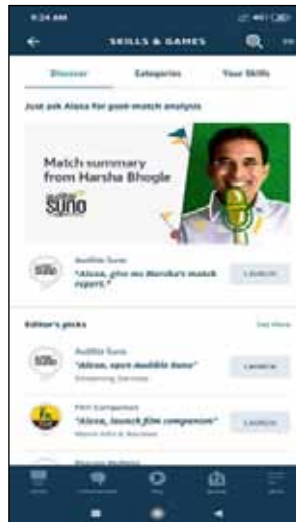

4. Search Havells Sync & Tap on Havells Sync in search results.

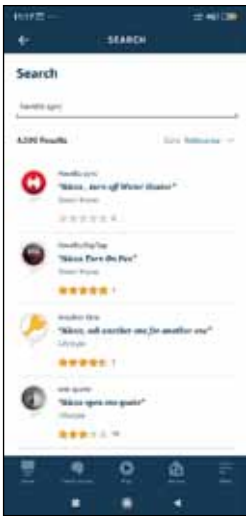

5. Tap on 'Enable to use' button
Havells Sync logging page will open

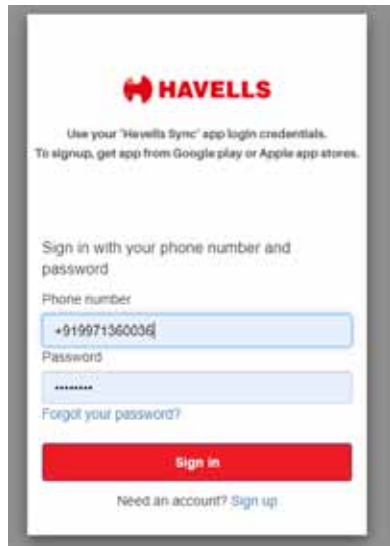
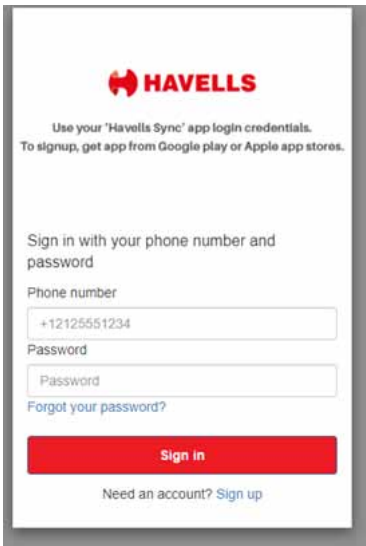

6. Sign in using your Havells Sync app login credentials. To signup, get app from Google play or Apple app stores. Enter your Phone number with +91XXXXXXXXX Enter 6 digit PIN of Havells Sync as password.

7. After Sign in, Your Havells Sync account will be successfully linked, if failed please try again.

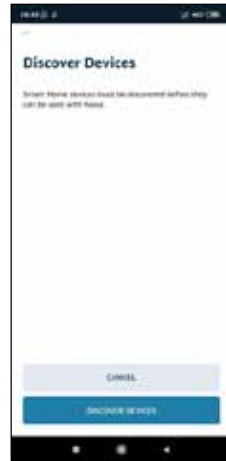
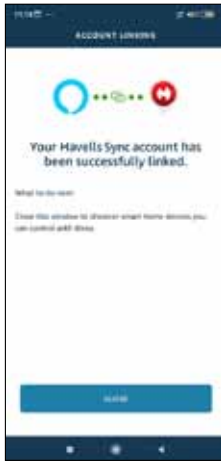

8. To discover and add device, follow the on-screen instructions.

1.2 Smart Assistant Alexa controls & status commands

Functionality	Alexa Utterance	Sample Alexa
Power		
Updating Power State	Hi Alexa, turn on <device name>	Hi Alexa, turn on Bathroom Water Heater
Updating Power State	Hi Alexa, turn off<device name>	Hi Alexa, turn off Bathroom Water Heater
Updating Power State when device is offline	Hi Alexa, turn on/off <device name>	Hi Alexa, turn on/off Bathroom Water Heater
Temperature		
Query Temperature	Hi Alexa, what is the temperature of<device name>?	Hi Alexa, what is the temperature of Bathroom Water Heater?
Controlling Temperature	Hi Alexa, set temperature of <device name> to 40 °C (degree celsius)	Hi Alexa, set temperature of Bathroom Water Heater to 50 °C (degree celsius)
Controlling Temperature	Hi Alexa, set temperature of <device name> to 100 °C (degree celsius)	Hi Alexa, set temperature of Bathroom Water Heater to 100 °C (degree celsius)
Controlling Temperature when device is offline	Hi Alexa, set temperature of <device name> to 40 °C (degree celsius)	Hi Alexa, set temperature of Bathroom Water Heater to 50 °C (degree celsius)
Mode Control		
Query Mode	Hi Alexa, what is the current mode on the <device name>?	Hi Alexa, what is the current mode on the Bathroom Water Heater?
Updating Mode	Hi Alexa, set <device name> to lukewarm	Hi Alexa, set Bathroom Water Heater to luke warm
Updating Mode	Hi Alexa, set <device name> to warm	Hi Alexa, set Bathroom Water Heater to warm
Updating Mode	Hi Alexa, set <device name> to hot	Hi Alexa, set Bathroom Water Heater to hot
Updating Mode	Hi Alexa, set <device name>r to very hot	Hi Alexa, set Bathroom Water Heater to very hot
Updating Mode when device is offline	Hi Alexa, set <device name> to lukewarm	Hi Alexa, set Bathroom Water Heater to luke warm

Alexa response's in case of not handling the user commands

Alexa Response I'm not quite sure what went wrong.
That command doesn't work on device Bathroom Water Heater. Bathroom Water Heater isn't responding.
I'm not quite sure what went wrong.
Bathroom Water Heater isn't responding. Please check its network connection and power supply.

2. Google Action Smart Assistant

2.1 Google & Havells Sync Account Linking process

1. Launch Google home app on your device

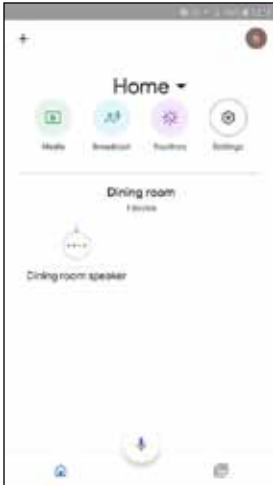

2. At the top right, tap on your profile icon.



3. Select 'Assistant setting'

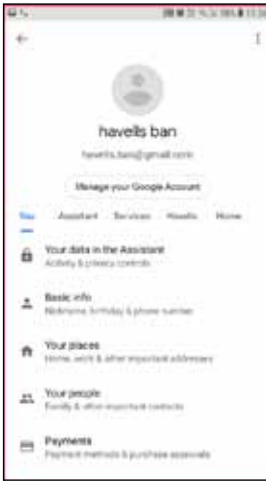

4. Go to Assistant tab

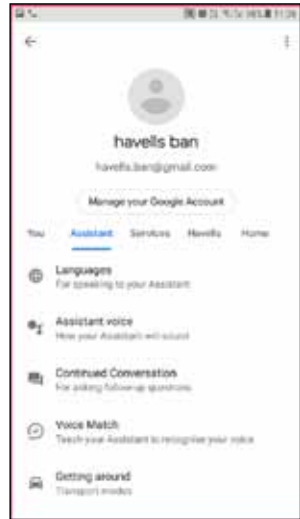

5. Scroll list to select 'Home control' to see list of google actions

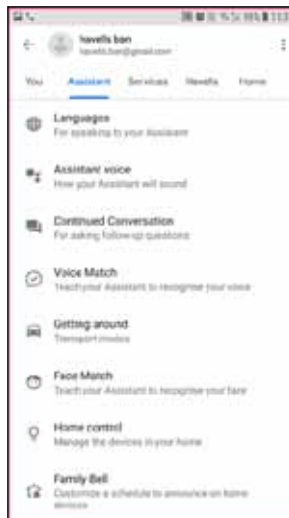

6. Now, search 'Havells Sync'



7. Select Havells Sync in search result, which will redirect you to account login page.

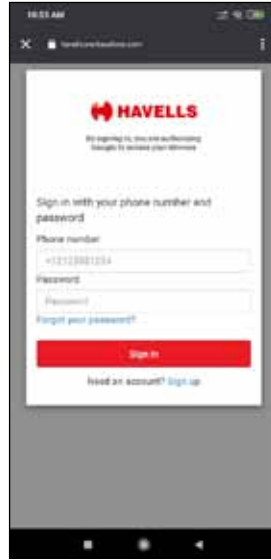

8. Sign in using your Havells Sync app login credentials. To signup, get app from Google play or Apple app stores. Enter your Phone number with +91XXXXXXXXX Enter 6 digit PIN of Havells Sync as password.



9. After successful Sign in, you will see list of your devices.



10. Start adding device to existing or new rooms

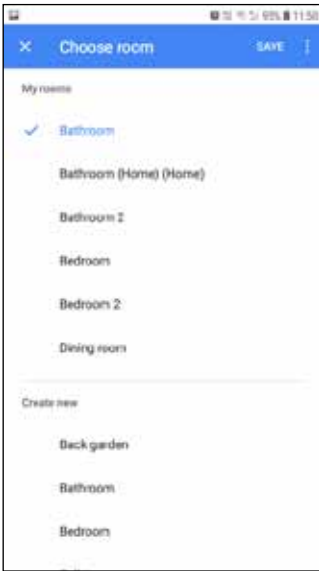

11. One device is added to the the room, tap on DONE button.



12. Now, you can follow the on-screen instructions shown by Google to control the devices.



13. Your devices will be shown in their respective rooms assigned by you

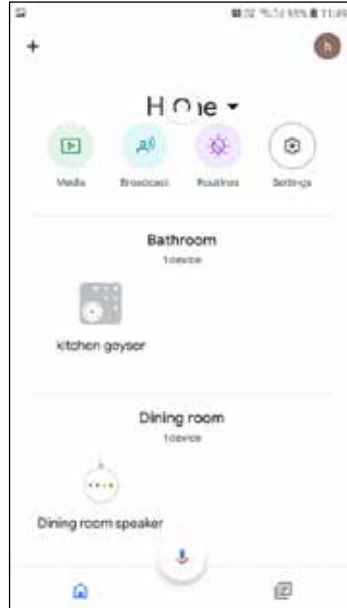

2.2 Smart Assistant Google Home controls & status commands

Functionality	Google Utternace	Google Example
Power		
Query Power	Hey Google, is <device name> turn on?	Hey/Ok Google, is bathroom geyser turn on
Updating Power State	Hey Google, turn on <device name>	Hey/Ok Google,turn on bathroom geyser
Updating Power State	Hey Google, turn off<device name>	Hey/Ok Google,turn off bathroom geyser
Updating Power State when device is offline	Hey Google, turn on/off <device name>	Hey/Ok Google,turn on/off bathroom geyser
Temperature		
Query Temperature	Hey Google, what is the temperature of<device name>?	Hey/Ok Google, what is the temperature of bathroom geyser?
Controlling Temperature	Hey Google, set temperature of <device name> to 40 °C (degree celsius)	Hey/Ok Google, set temperature of bathroom geyser to 40 °C (degree celsius)
Controlling Temperature	Hey Google, set temperature of <device name> to 100 °C (degree celsius)	Hey/Ok Google, set temperature of bathroom geyser to 100 °C (degree celsius)
Controlling Temperature when device is offline	Hey Google, set temperature of <device name> to 40 °C (degree celsius)	Hey/Ok Google, set temperature of bathroom geyser to 40 °C (degree celsius)
Mode		
Query Mode	Hey Google, is <device name> set warm?	Hey/Ok Google, is bathroom geyser set warm
Updating Mode	Hey Google, set <device name> to lukewarm	Hey/Ok Google, set bathroom geyser to lukewarm
Updating Mode	Hey Google, set <device name> to warm	Hey/Ok Google, set bathroom geyser to warm
Updating Mode	Hey Google, set <device name> to hot	Hey/Ok Google, set bathroom geyser to hot
Updating Mode	Hey Google, set <device name>r to very hot	Hey/Ok Google, set bathroom geyser to very hot
Updating Mode when device is offline	Hey Google, set <device name> to lukewarm	Hey/Ok Google, set bathroom geyser to lukewarm

B. Using the water heater in manual mode:

1. Do not switch “ON” before filling the heater with water.
2. Leave the hot water tap open. Now fill the heater by opening the control valve at the inlet.
3. When the heater is full, water will start flowing through the hot water tap. Close the hot water tap.
4. Now the heater will always have water inside. Water drawn will be replaced by water from the over head tank.
5. Always keep the inlet control valve open.
6. Now switch “ON” the power supply to the heater.
7. To set the temperature manually, press the '+' / '-' buttons on the device. When done, the display will blink 3 times showing set temperature post which it will show the current temperature of the device.

B. Using the water heater regularly :

1. Always keep the inlet valve open so that water drawn from the hot water tap is automatically replaced from the mains.
2. When the water reaches the required temperature the thermostat will cut-off the power supply automatically.

LED color	Indication
Blue or any color (except amber)	Water is heating
Amber	Water is heated to set temperature

3. The thermostat setting can be changed by the user to suit outlet water temperature.
4. Lowering the setting of the thermostat will give a lower hot water temperature; increasing the setting will give a higher hot water temperature.
5. Initially it may take a long time for the water to get hot, it is recommended to switch “ON” the water heater at least an hour before you want to use it.
6. If you require hot water early in the morning, switch “ON” previous night itself, thermostat would cut-off the power automatically, when the water reaches the set temperature.
7. The heater can also be kept “ON” always, if required since the heater is completely insulated, the water will remain hot. The thermostat will cut-in and cut-off automatically to keep the water at constant temperature. In this way you can always get hot water.
8. To manually reset the device, press and hold the '+' and '-' button on the device together for 5 s. 'Fy' will appear on the display post which the default temperature '65' will blink 3 times on display confirming the reset of your device.
9. The factory-set temperature is 65 °C

Maintenance & Cleaning:

1. To benefit from the highest standards of service and to ensure your guarantee remains in focus, please always contact HAVELLS approved dealer or HAVELLS Authorised Franchise
2. Always keep the inlet control valve open.
3. Never switch “ON” the water heater without water in the heater. It will damage the heating element.
4. Check condition of metal flexible pipe at-least once in a year. If found damaged replace with new pipes.
5. Check the condition of power & supply cord for “No Damages”. Replace it by an authentic supply cord in case of any damage.
6. If the water heater is not going to be used for a long time,
 - a. Plug Off the power supply,
 - b. Stop Inlet water supply
 - c. Unscrew the drain lever, lift the lever upward to remove the water through drain system provided in MFV.
7. To increase the life of heating element, de-scaling should be done periodically. if required, you may take the assistance of the nearest authorized service center
8. During reuse of water heater
 - a. Ensure Drain Plug lever is reset and screwed
 - b. Open Inlet Valve and fill the water heater till the clean water flows from outlet tap.
 - c. Plug-in the power supply to heat the water
9. Periodically check the MFV to ensure that it is in operating condition. The MFV should be operated regularly to remove salt deposits and to verify that it is not blocked.
10. Check proper functioning of the safety valve in every two months by opening and closing the test lever.
11. The heating element should be checked every year for “No Scale Formation” caused by impurities in the water supply.
12. We recommend to check Magnesium anode rode in every year & once it has been used up over 60%, the Magnesium anode should be replaced with a new one.

For cleaning the element or replacing the anode use the following procedure:

1. Switch off the electric supply to the water heater.
2. Open the hot water taps until the hot water is removed completely.
3. Close inlet cold water supply.
4. Drain the cold water from tank through MFV drain pipe by lifting the drain lever. Remove flexible pipe.
5. Remove the water heater from the hanger hook, after water heater is emptied
6. Remove the Service cover from front, unscrew the heating assembly flange.
7. Clean the container and the heating element assembly to remove scale formation, by using a suitable acid or by gently scraping the scale. Check the heating element surface after cleaning for “No Surface Damage”
8. Replace Magnesium anode in case it is worn out.
9. Remount the heating assembly flange. Ensure the Internal wiring connection are made as per the wiring diagram shown in the manual.
10. Hang the water heater on the mounting bracket/ hook provided on the wall. Move the water heater down- ward to ensure that it is seated on bracket properly.
11. Open cold water supply until water flows without interruption from outlet valve.
12. Close the outlet valve and check for “No eventual leakage” around the flange and water connections.
13. When there is no leakage, put back the service cover and then switch on electric supply.

DO'S

1. The gate valve at the inlet should always be kept open.
2. To minimize scaling of heating element & the tank, (which takes place rapidly in areas of hard water), drain the water from heater unit periodically. However get this done through a qualified technician /plumber only
3. Always get the water heater serviced once in a year from a Havells authorized service representative
4. Use genuine spares when spares replacement is necessary.
5. Switch OFF the power supply to the unit & drain out the water when not in use for a longer period of time. This prevents scaling of the element.
6. In case both the lamps do not glow, do not start the unit by resetting the thermal cutout Instead contact the nearest customer care center.

DON'T

1. Safety devices like safety valve, thermostat, thermal cut-out etc. are pre-set from factory & sensitive devices. Do not tamper with them, this could be hazardous.
2. Do not switch ON the heater till it is completely filled with water.
3. In case you observe any abnormality of operation, immediately switch OFF the main power supply to the unit and contact the nearest customer care center.
4. Never install a pressure reducer valve at the inlet.
5. Do not install in area of direct sunlight and water splashes.

WARRANTY*

M/s. Havells India Ltd. ("Company") hereby offers a limited warranty ("Warranty") against manufacturing defect/s for a period of 2 (two) years on this Water Heater ("Product"), 7 (seven) years on its inner container and 4 (four) years on its heating element from the date of invoice on the terms and conditions provided hereinafter.

WARRANTY TERMS AND CONDITIONS

To claim Warranty, it is mandatory that the customer provides the original invoice and wherever possible original Warranty certificate (duly signed and stamped by the selling dealer) must be presented by the customer.

To avail Warranty services, the customer can log in his complaint with the customer care cell.

This Warranty is valid only in respect of the Product purchased in India.

This Warranty is limited to the first purchaser of the Product only.

It is clarified that after two years from the date of invoice, Company's responsibility to continue to provide additional Warranty services in terms as agreed upon shall however be limited only to supply of the parts free of cost and any cost(s) incurred towards labour, transportation and any other incidental expenditure for providing the said Warranty services shall be borne by the customer.

The decision to repair or replace any part of the Product shall be at the sole discretion of the Company.

In case of repair or replacement of any part of the Product during the said Warranty Period, the Warranty of the repaired or replaced part shall thereafter continue only for the unexpired period of Warranty.

If the Product is not repairable at the place of installation then the decision of the Company's Authorized Service Representative to take the Product to the service center for repair shall be final. Company's decisions on all questions and complaints regarding the defects, shall be conclusive.

The defective spare parts shall be sole property of the Company or its Authorized Service Partner during the Warranty Period.

In the event of any unforeseen circumstance, and/or spares are not available, Company's prevailing depreciation rules will be binding on the customer to accept as a commercial solution in lieu of repairs.

The depreciation rule will be applicable after one year from the date of purchase.

To avail Warranty services for the Product, any recommendations made by the Company's visiting Authorized Service Representative shall be complied by the customer and if that recommendation requires repair of any electrical installations, wiring or of any third party product attached to the Product, it shall be first undertaken by the customer at his entire cost. Thereafter, the Warranty for the Product can be availed.

Company shall not be held liable or be deemed to be in default for any delay or failure in performance resulting directly or indirectly from causes beyond its control including delay in repairing due to non-availability of any component or accessory, labour problem, restrictions and regulations of the government, public movement, war and any other unavoidable/unforeseen circumstances including any force majeure event, specially vis-à-vis the import of supplies and raw material.

The Warranty provided herein is in lieu of implied conditions and warranties under the law and is confined to the repair or replacement of defective parts and does not cover any economic loss, commercial loss, consequential or resulting liability, damage to the property, or any other harm or loss.

None of the employees and /or Authorized Dealers of the Company have any authority whatsoever to vary the Terms and Conditions of this Warranty.

In the event that any Terms and Condition of this Warranty becomes invalid and/or unenforceable, the remaining Terms and Conditions shall continue in full force and effect.

WARRANTY EXCLUDES OR DOES NOT APPLY:

- If the Product or any of its parts/accessories are not properly installed, used, maintained or operated as per the user manual or Product specifications.
- If the Product is serviced or repaired by any person other than the Authorized Service Representative of the Company.
- If customer violates Warranty Terms and Conditions, instruction manual guidelines, recommendations of Authorised Service Representative and/or operates the Product otherwise than as per Product specifications.
- If the serial number affixed by the Company on the Product or any part thereof is damaged, defaced, obliterated or erased/ tampered with for any reason whatsoever or if Product is refurbished/modified.
- If the Product is operated in conditions otherwise than normal conditions (e.g., abnormal voltage surge, extreme heat, corrosive/alkaline/acidic atmosphere, dust ,damage from sea water, pollution, chemical environment ,extreme environmental conditions, sulfur in the air, installation near the open drainage system etc.).
- If the Product is installed in direct sunlight, rain, water splashes etc.
- If safety valves and anodes are not kept under right working conditions.
- If multi-functional safety valve is not used or installed with the Product.
- If the Product is used for any commercial purpose.
- Any harm caused due to accident, negligence, improper maintenance, mishandling, tampering, incurred in transit by the customer or which can be attributed to the fault of the customer.
- Any harm resulting from any unforeseeable circumstances such as force majeure event etc.
- Any harm caused due to any defect in any electrical/civil installation(s), wiring or third party products.
- Any liability resulting from any un-authorized adaptations, attachments and/or adjustments to the Product or from a third party apparatus or equipment.
- Any damage caused due to quality of water, scaling or sediment deposits in the water tank.
- Any damage to the Product due to household pets, rodent or any other insect/animals.
- Corrosion, rusting, plastic parts & accessories.

Customer Name _____ **Model No.:** _____

Serial No. _____ **Invoice No.:** _____

Date of Purchase: _____

Dealer's Name, Address:

Dealer's Seal & Signature

Actual products may vary in colour, design, description and colour combination etc.
Although every effort has been made to ensure accuracy in the compilation of the technical detail within this Publication.
Specifications & performance data are constantly changing.
Copyright Subsists. Imitation of trade dress, graphics and color scheme of this document is a punishable offence.
Figure and Drawings are for illustrative purpose only.



180521/V1

Havells India Ltd.

Corp Office: QRG Towers, 2D, Sector-126, Expressway,
Noida-201304 (U. P.) India Ph. +91-120-4771000

Email : customercare@havells.com, Website: www.havells.com

Customer Care No. 08045 77 1313 (All Connections), 011-4166 0303 (Landline)

Join us on Facebook at www.facebook.com/havells and share your ways to save the planet !

CIN - L31900DL1983PLC016304